PULNiX

**TM-6701AN
DOUBLE SPEED
PROGRESSIVE SCANNING
FULL FRAME SHUTTER CAMERA**

**OPERATIONS &
MAINTENANCE MANUAL**

Table of Contents

1.	Features and Applications	2
	Miniaturization and Light Weight	2
	Imager	2
	Asynchronous Reset	2
	Asynchronous Image Capturing	2
	Integration	3
	VGA Display Output	3
	Special Functions	3
	Progressive Scanning	4
2.	Specifications	5
	Imager	5
	Camera	5
	Spectral Response	6
3.	External Connector and Switches	6
	12-Pin Connector	6
	Shutter Control Switch	7
	Double Speed, Partial Scan Mode	7
	Non-Interlace Black and White Monitors	7
4.	Physical Drawing	8
5.	Board Layout and Factory Setting	9
6.	CCD Principle and Camera Operations	9
	Substrate Drain Shutter Mechanism	9
	Asynchronous Shutter	10
	External Pulse Width Control Mode	10
	Internal Fast Reset Mode	11
	Internal Slow Reset Mode	11
7.	Pixel and Vertical Frame Output Timing	12

1. Features and Applications

The TM-6701AN is a state-of-the-art CCD camera which uses 1/2 inch progressive scan interline transfer CCD imager. This CCD camera offers outstanding compactness, double speed scan, asynchronous reset and electronic shutter, non-interlace 60 Hz analog video (VGA), partial scanning and number of technical innovations. The camera's various features allow for versatile applications such as high speed image capturing, machine vision, computer graphics, gauging, avionics, microscopy, character and fine pattern recognition, document reading and high end surveillance.

Miniaturized and Light Weight

All PULNiX cameras are built with the same design principles:

- Solid state technology;
- Miniaturization;
- Specific application such as remote imagers and special functions for various application needs;
- Robust design even for military applications.

Imager

The TM-6701AN uses 1/2" progressive scan interline transfer CCD with built-in micro-lens. The reasons of such CCD are:

- High resolution (648H x 484V active pixels)
For very high resolution and image quality.
- Square pixel (9.0 x 9.0 μm)
Precise dimensional measurement ability.
- High speed electronic shutter capability with
High dynamic resolution of moving object.
Electronic iris control.
Elimination of mechanical shutter.
- Progressive scan
Eliminates interlace deterioration of image
Ease of computer interface.
- High sensitivity and low noise at fast scanning
Can drive faster than 25 MHz pixel clock rate.
Excellent S/N ratio (>50 dB).
Micro lens on chip.
- Partial scan capability
Allows 120 Hz two-row scanning, 100 and 200 lines partial scan.

Asynchronous Reset

The TM-6701AN can be reset with an external reset pulse (VINIT). When VINIT is enabled at Async mode, the camera keeps discharging from CCD. With the VINIT leading edge (negative going) pulse, it resets the internal timing and starts integrating for the preset period of shutter timing and outputs the async shutter video. This feature is especially important to capture the moving objects at precise location of the field of view such as belt conveyer, fast event observation and still picture capturing.

Async Image Capturing

The TM-6701AN captures async reset image and outputs the full frame video. It requires an asynchronous resettable frame grabber to capture the async reset image.

Integration

The TM-6701AN is capable of outputting long term integrated images with high resolution. The integration can be longer than 1/60 sec to a few seconds without significant noise. For uniform and low noise integration, PULNiX offers a peltier cooled CCD option.

VGA Display Output

Since progressive scan cameras are no longer in TV format, the display of the video signal is only achieved by using a frame grabber and computer or a special monitor. The TM-6701AN has a feature of VGA output which scans 525 lines at 60 Hz non-interlace.

PULNiX PVM1200 series monitors or equivalent B/W multi-sync monitor can display the non-interlace images. Consult PULNiX for display monitor information.

Special Functions

- **Asynchronous Reset Mode** (Select switch on the back panel for ASY...async)

When External VINIT is high (5V), the TM-6701AN expects the async pulse input and the video output is black video (output inhibit). It resets at the negative going pulse edge and captures the frame regardless of the shutter speed (fast or slow mode). The video output is kept disabled as CCD is discharged continuously during VINIT high. When the first VINIT pulse comes in, it resets the timing and outputs the image. If the switch is NRM (normal mode.... manual shutter mode), the video output is real time with manual shutter.

- **Integration**

The integration function is activated by keeping INTEG control(#11 of 12-pin connector) as active low (TTL). During low, the TM- 6701AN keeps integrating and, upon the rising edge of the INTEG control pulse, it outputs the frame.

Progressive Scanning

Standard TV system scanning is 525 line interlace scanning as specified in RS170. Every other horizontal line (ODD lines and EVEN lines) are scanned at a 60 Hz rate per field, and completes scanning with two fields (one Frame) at 30 Hz rate. Because of the interlace scanning, vertical resolution of CCD cameras is limited at 350 TV lines regardless of horizontal resolution. When electronic shutter is applied, the CCD can hold only one field of charge at each exposure. Therefore, the vertical resolution of the electronic shutter camera is only 244 TV lines. This is the same situation even for HDTV format camera since it is interlaced scanning and the vertical resolution of shuttered image is 500 lines. The TM-6701AN uses a state-of-the-art CCD called a "Progressive scanning interline transfer CCD" which scans all lines sequentially from top to bottom at one frame rate (60Hz). Like a non-interlace computer screen, it generates a stable and crisp image without alternating lines and provides full vertical TV resolution of 484. The interline transfer architecture is also important to generate simultaneous shuttering. This is different from a full frame transfer architecture which requires a mechanical shutter or strobe light in order to freeze object motion. The TM-6701AN outputs the progressive scanning image with electronic shutter in three different formats (see section 3 for external switches setting):

- **Progressive Scanning Double Speed Output** (Normal mode. Select N,O)

Straight forward signal output equivalent to non-interlace VGA format (60 Hz). It is a real-time double speed CCD output through normal analog video processing into 75Ω 1Vp-p output format .

- **Progressive Scanning 120 Hz Output** (Rear switch: N, T)

The CCD signal of each rows are combined together to scan 242 lines. The frame speed is therefore, 120 Hz of non-interlace video. The async reset, electronic shutter and integration function works as normal. The analog output is the same as 75Ω, 1Vp-p format at 120Hz rate. This mode provides 120Hz scanning of full field of view but the vertical resolution is only 242 lines.

- **Partial Scanning Output** (Rear switch: P, T for 100 lines, P,O for 200 lines)

By setting the switch to 100 line partial scan, the TM-6701AN outputs the bottom 100 lines of video. It repeats the same lines at a rate of 222 frames/sec with the fast dump blanking of unused lines. The asynchronous reset and electronic shutter functions are maintained at each partial scan. By selecting 200 lines it outputs the bottom 200 lines of video at a rate of 130 frame/sec.. The partial scan keeps the same resolution as full progressive scan and only the field of view is narrow.

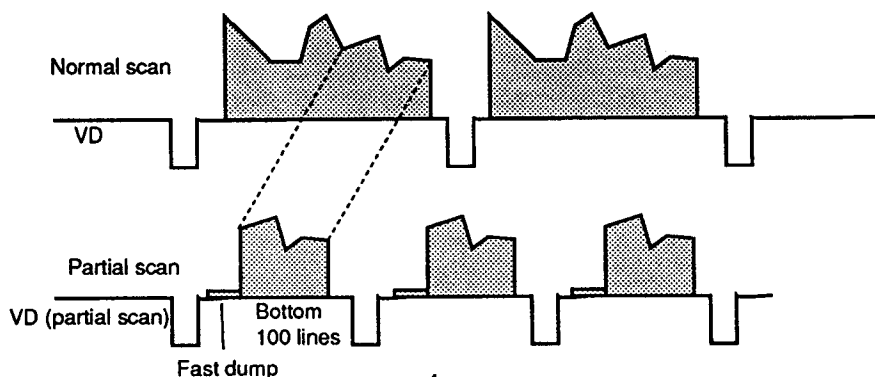

2. Specifications

Imager

Imager	1/2" Progressive scan interline transfer CCD (with micro-lens)	
Total pixels	694 (H) x 496 (V)	
Photosensitive pixels	648 (H) x 484 (V)	24 + 8 ob(H), 4 + 8 ob (V)
Photosensitive area	5.83 (H) x 4.36 (V) mm	
Pixel size	9.0 (H) x 9.0 (V) μm	
Output sensitivity	12 $\mu\text{V}/\text{e}^-$	
Micro lens	Standard	

Blemish	Point defect	Cluster	Column
Class 0	No defect	0	0
Class 1	<5	0	0
Class 2	<10	<4	<2
Class 3	<20	<8	<4

Camera

Scanning	525 lines 60 Hz (double speed mode)
Sync	Internal / External auto switch HD / VD, 4.0 Vp-p impedance 4.7 K Ω fHD = 31.468 KHz fVD = 60 Hz
Pixel clock	25.49MHz
TV resolution	500 (H) x 484 (V)
Minimum illumination	2.0 lux, f = 1.4 without IR cut filter
S/N ratio	50 dB min. AGC = Off
Video output	Analog 1.0 Vp-p composite video, 75 Ω , sync negative Non-interface
Display mode video	Analog only fHD = 31.468 KHz, fVD = 60 Hz (VGA)
AGC	On / Off (off = std)
MGC	Manual gain adjustable (6 dB to 26 dB)
Gamma	0.45 or 1.0 (1.0 = std)
Lens mount	C-mount.
Power requirement	12 V DC 500 mA
Operating temperature	-10° C to 50° C
Vibration and shock	Vibration:: 7G (200 Hz to 2000 Hz), shock: 70G
Size	45.8mm x 39.4mm x 144.6mm (1.80" x 1.55" x 5.69")
Weight	260 grams (9.2 oz)
Power cable	12P-02
Power supply	K25-12V or PD-12

Spectral Response

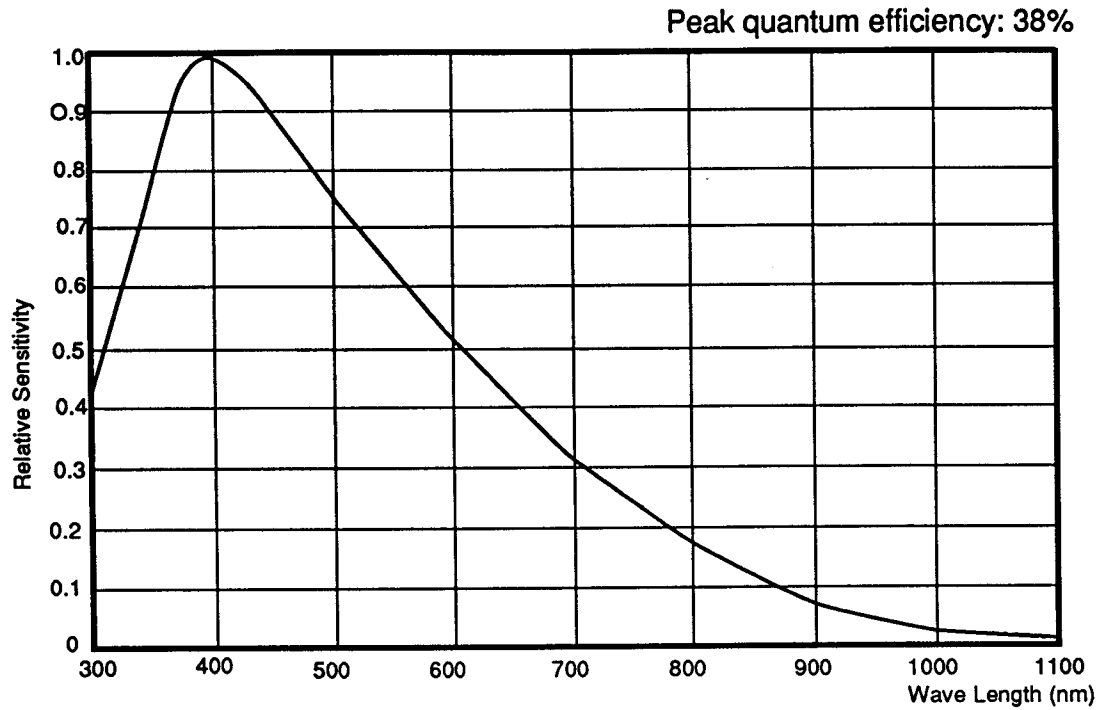

3. External Connector and Switches

12-PIN Connector

1. GND
2. +12V DC
3. GND
4. Video Out (*Pixel Clock Output)
5. GND
6. VINIT In
7. Vd In (*VD OUT)
8. GND
9. Hd In (*HD OUT)
10. GND
11. Integration Control
12. GND

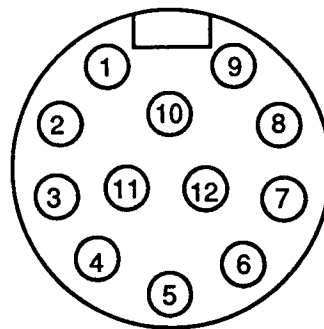

* Standard OP-7-2 for TM-6701AN cameras.

Shutter Control Switch

Manual shutter mode		Async reset mode	
0	no shutter	no shutter	
1	1/125	1.0H	1/32000
2	1/250	2.0H	1/16000
3	1/500	4.0H	1/8000
4	1/1000	8.0H	1/4000
5	1/2000	16 H	1/2000
6	1/4000	32 H	1/1000
7	1/8000	64 H	1/500
8	1/16000	128H	1/250
9	1/32000	Pulse width control	

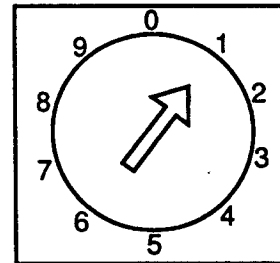

SH CONTROL

- Mode 0: Normal mode
- Mode1-4: Fast mode
- Mode5-8: Slow mode
- Mode 9: Pulse width mode

Double Speed, Partial Scan Mode

One of the advantages of the TM-6701AN is the fast scanning mode. Although normal progressive scanning frequency is too slow to display on a TV monitor, the double speed output allows the analog video format at 31.5 KHz horizontal, 60 Hz vertical frequency be displayed by VGA monitors. For various speed scanning, select switches on the back panel for double speed, 120 Hz two-row scan, 100, 200 partial scan.

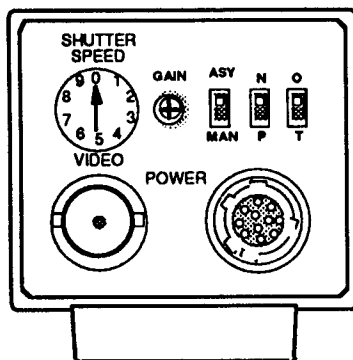

Normal mode:	N	O	(60 Hz progressive scan)
Double scan:	N	T	(120 Hz two row scan)
100 line scan:	P	O	(222 Hz progressive scan)
200 line scan:	P	T	(130 Hz progressive scan)

Note: N-normal;
P-partial;
O-one hundred lines;
T-two hundred lines

Non-Interlace B/W Monitors

PULNiX offers non-interlace monitor (42-5002).

PVM942 /1242 or equivalent model can be used for TM-6701AN's various display mode.

For the standard operation, including RS-170 interlace, 60 Hz non-interlace, 30 Hz non-interlace and 120 Hz non-interlace (two-row scanning mode of TM-6701AN), it displays as normal.

For the partial scanning display, it extends the vertical to fill the monitor screen and the images will be distorted vertically.

4. Physical Dimensions

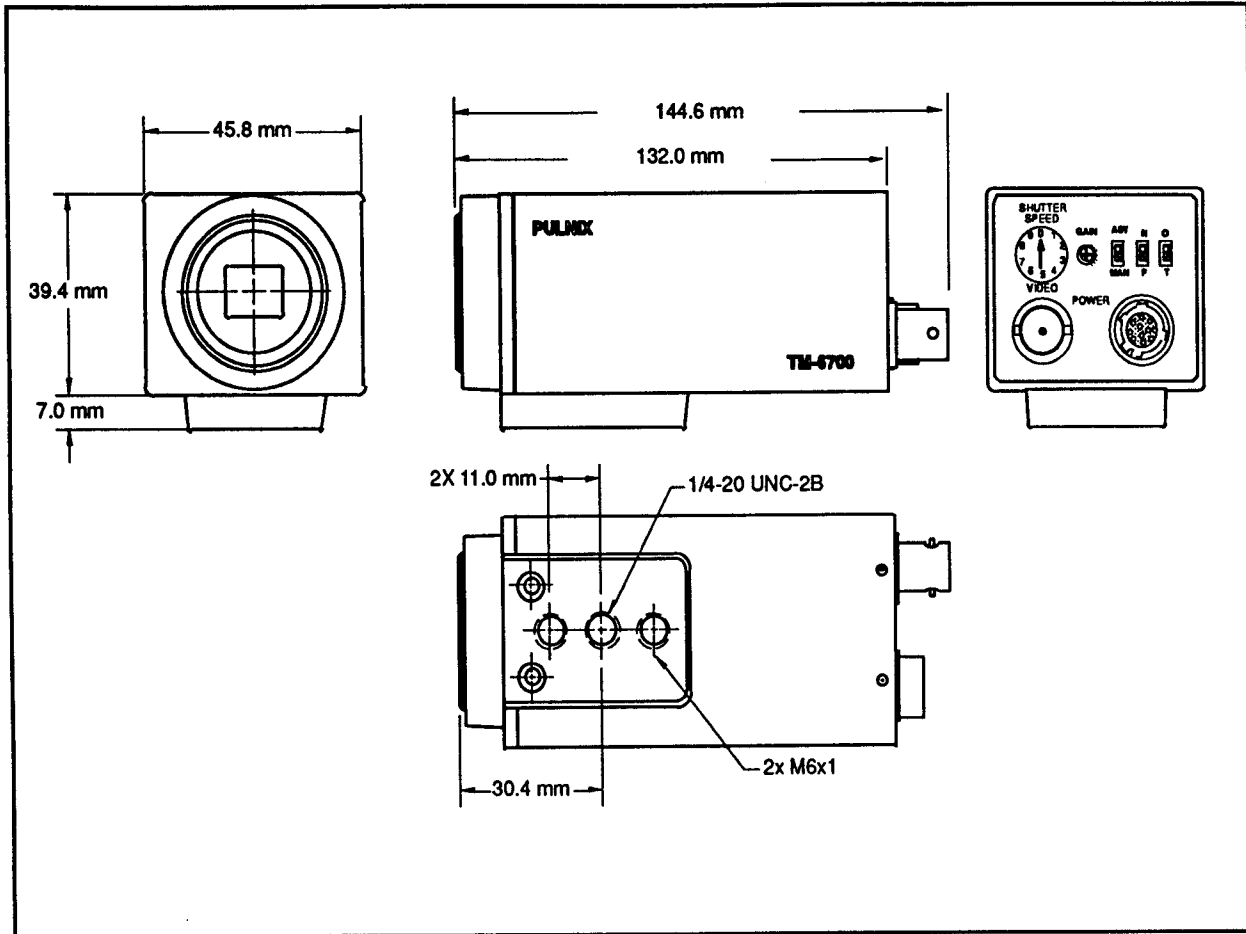

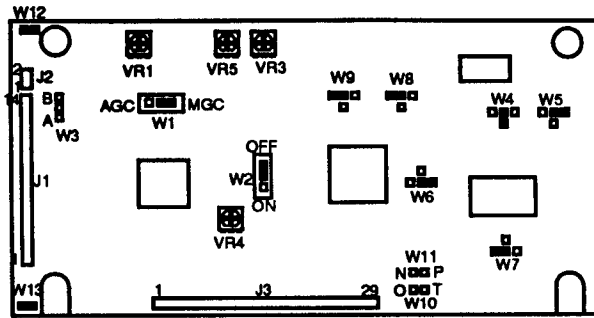

Top Board Factory Setting

W1 AGC/MGC MGC (Closed to Right)
 W2 Gamma 1.0 (Closed to Top)
 W3 A/B selection Select A
 W4 - W9 CDS pulse delay adjustment
 W10,W11 Partial scan mode selection

VR1 AGC Set at 2.0 V
 VR2 MGC Control from back plate
 VR3 AGC MAX Set at 2.5 V
 VR4 PED Set at 50 mV of video
 VR5 RG Factory adjustment only

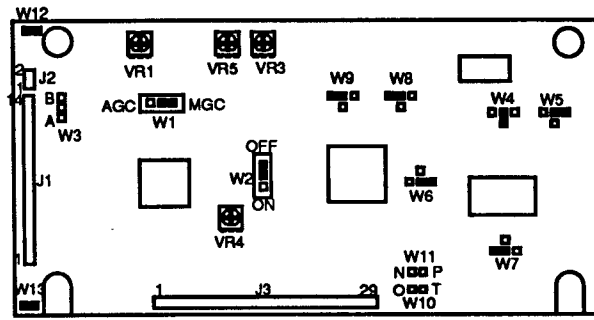

Bottom Board Factory Setting

VR1 VD phase adjustment
 VR2 PLL adjustment

6. CCD Principle and Camera Operations

Substrate Drain Shutter Mechanism

Normal operation requires the CCD chip to construct an individual potential well at each image cell. The potential wells are separated from each other by a barrier. The barrier is sequentially removed to transfer the charge from one cell to another by pixel clock. This is the basic principle of CCD operation for charge transfer. The substrate drain vertically moves the charges. When excess potential is applied to substrate underneath each cell, a potential barrier is pulled down to release the charge into the drain. This can happen to all the cells simultaneously, whereas normal CCD shuttering is achieved with a horizontal charge shift to the drain area by interline transferring or reverse transferring of the frame transfer chip.

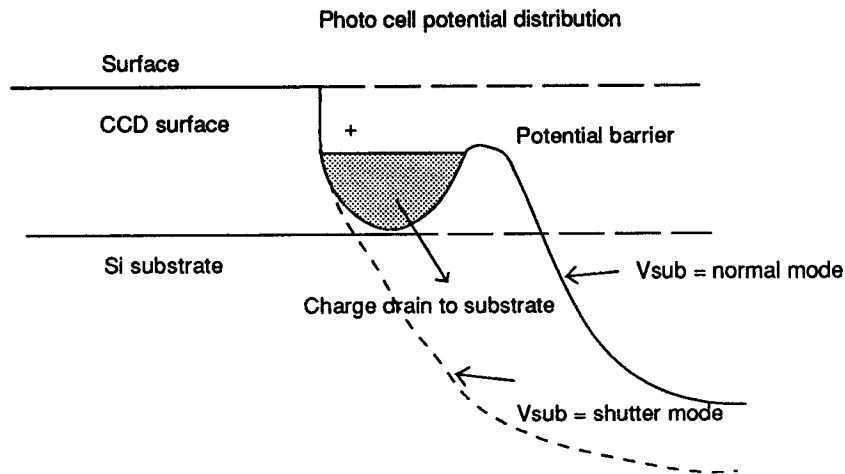

Asynchronous shutter

For Async Shutter mode, select "ASYN" rear switch of the back plate and provide external HD for phase locking. When the negative going reset pulse is applied, the camera will latch the falling edge to its next horizontal drive and reset vertical sync timing immediately. Therefore, the horizontal phase won't be interrupted. The TM-6701AN asynchronous camera outputs a full frame of shuttered video in progressive scanning format.

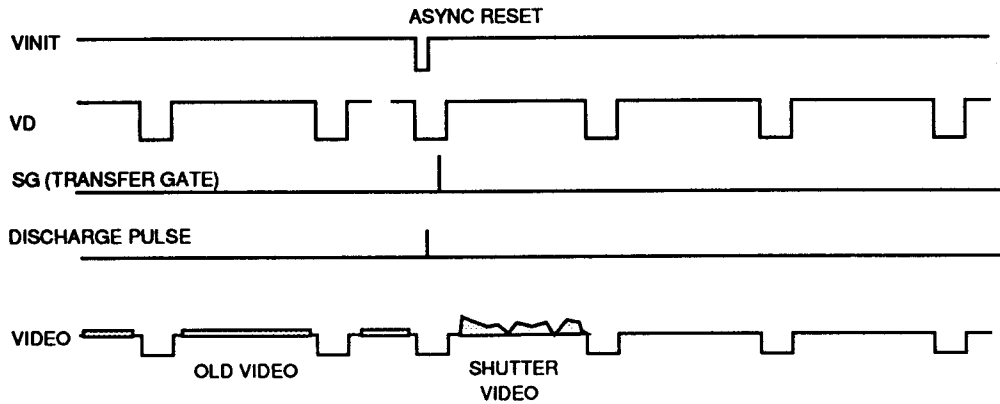

External Pulse Width Control Mode

For External Pulse Mode, set dial switch to "9". Apply an external VINIT pulse width signal to the camera, and the internal reset pulse will be latched at 9th HD from external falling edge pulse. CCD discharge pulse is generated to clear the images, and it always occurs until 9H at the external falling edge pulse. The internal VINIT resets internal timing including the video sync. The shutter speed (exposure time) is same as the external pulse width, X, but there is a 9H integration delay from the falling edge (for immediate reset option, please contact PULNiX). One frame of video output will start from the rising edge of the pulse width control for progressive format. At async mode, with external pulse input high, the video output is disabled as the camera keeps discharging CCD image and only provides black video.

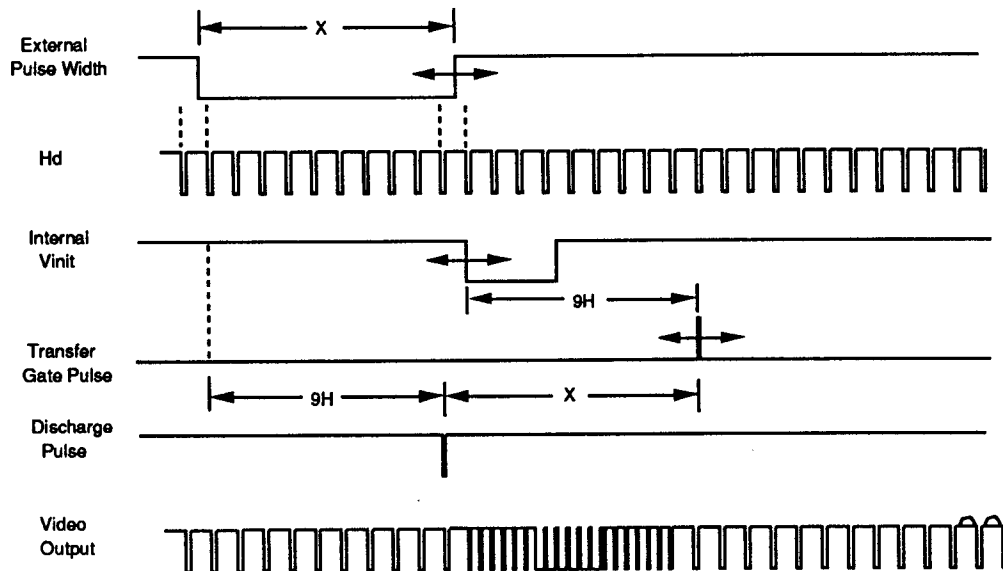

Internal Fast Reset Mode

For Internal Fast Reset Mode, set 10-position dial switch from "1" to "4". When fast reset mode is selected, the camera resets with internal VINIT timing, which is latched to Hd, and video output is also synchronized with internal VINIT timing without further delay. The shutter speed is controlled by the dial switch.

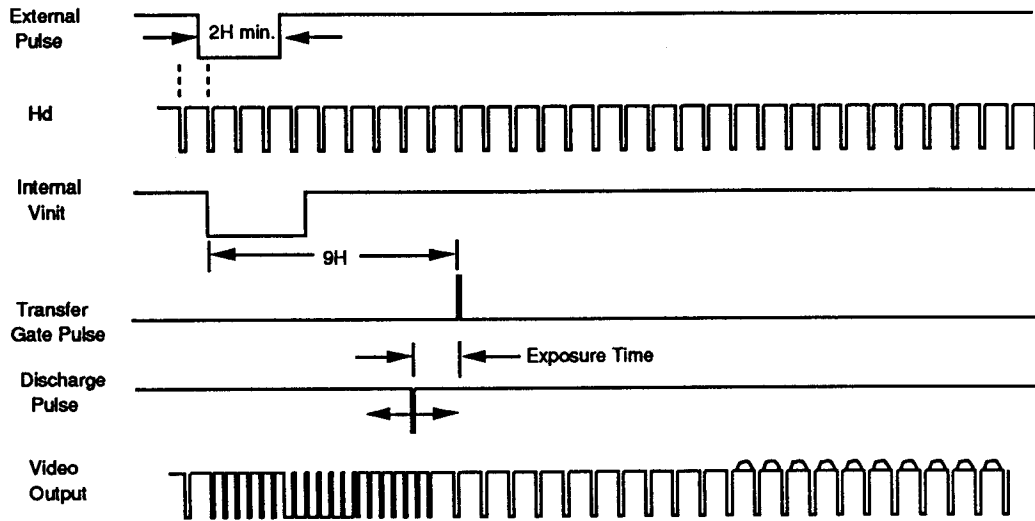

Internal Slow Reset Mode

With the Internal Slow Reset mode selected, the camera operates the reset and shutter in the same means as the external Double Pulse mode. When external VINIT pulse is applied, internal VINIT is latched to Hd and the second internal VINIT signal is generated to set up the shutter speed period. The shutter speed is controlled by setting the dial switch from "5" to "8". Video output timing starts right after the second internal reset. For the timing of the second internal reset, LPULSE output of 31-pin connector can be used.

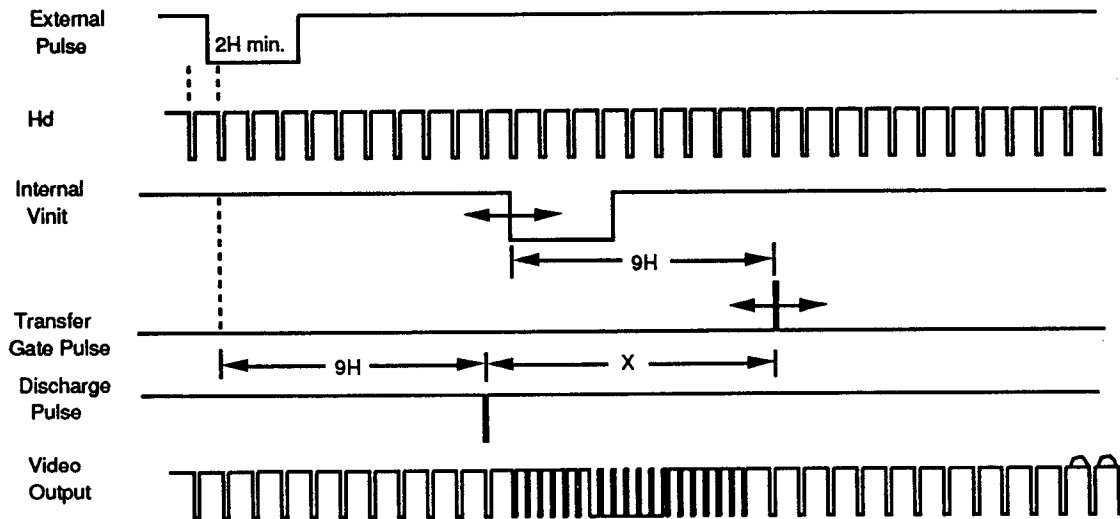

Pixel Mapping

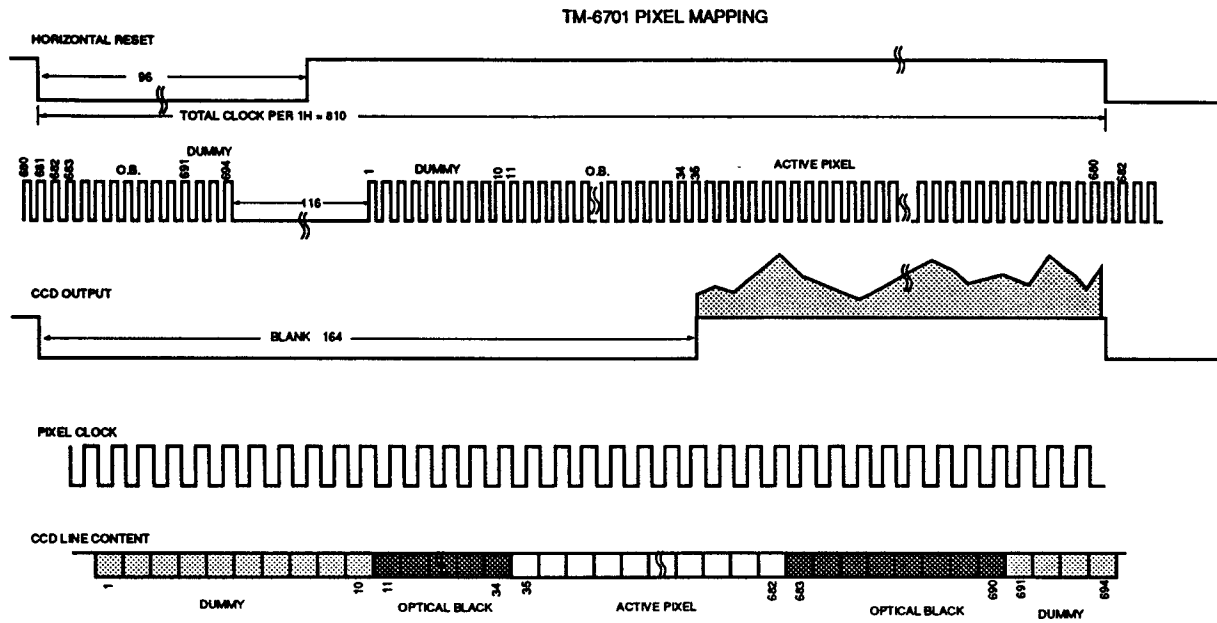

Vertical Frame Timing

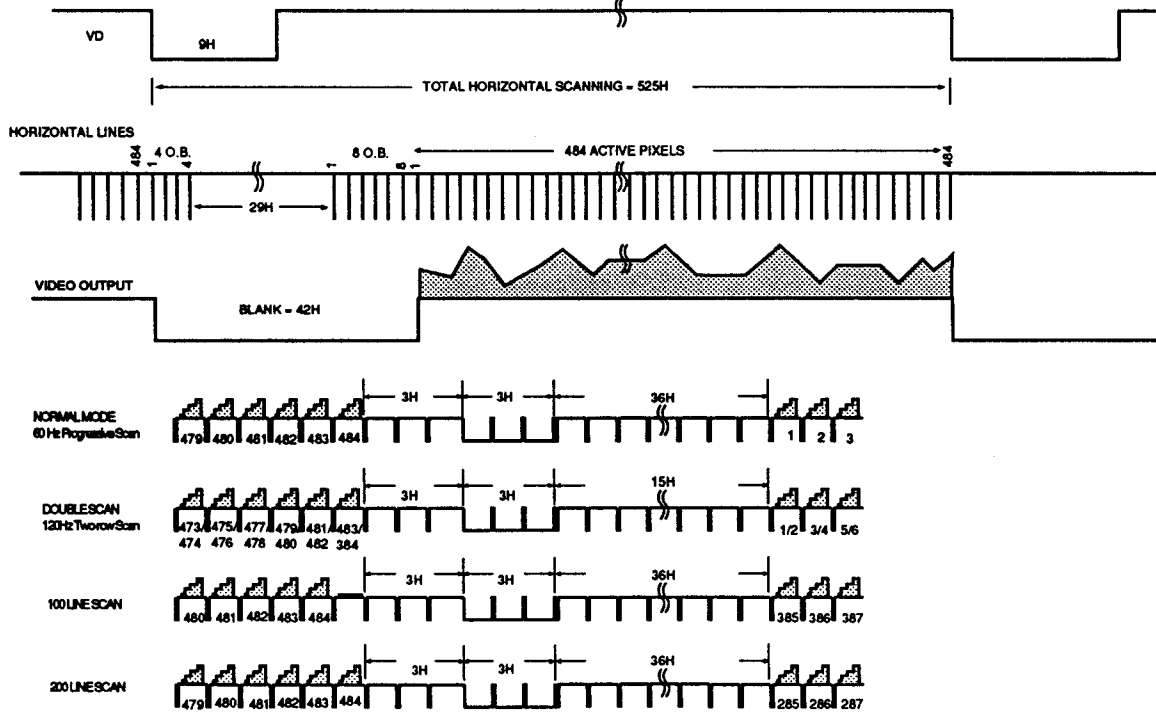



Notice

The material contained in this manual consists of information that is proprietary to Pulnix America, Inc., and may only be used by the purchasers of this product. Pulnix America, Inc. makes no warranty for the use of its products and assumes no responsibility for any errors which may appear or for damages resulting from the use of the information contained herein. Pulnix America, Inc. reserves the right to make changes without notice.

Warranty

All our solid state cameras have a full three year warranty. If any such product proves defective during this warranty period, Pulnix America, Inc. will repair the defective product without charge for parts and labor or will provide a replacement in exchange for the defective product. This warranty shall not apply to any damage, defect or failure caused by improper use or inadequate maintenance and use.

Revised Printing: October 1995

Pulnix America, Inc.

1330 Orleans Drive,
Sunnyvale, CA 94089
Tel: (408) 747-0300
(800) 445-5444
Fax: (408) 747-0880