



Test Report

Test Report No. IE1509-013T2
Date of Issue: 16th October, 2015

FCC Part 15 Subpart B

Radio Frequency Devices

Applicant Information	
Name of Applicant	: JAI CORPORATION
Address	: 10-35 Sakae-Chou, Kanagawa-Ku, Yokohama, Kanagawa, 221-0052 Japan
Telephone	: +81-45-440-0165
Facsimile	: +81-45-440-0167
Equipment under Test (EUT)	: CMOS CAMERA
Model Number	: SP-5000M-USB
Serial Number	: 82 000005
EUT Condition	: Pre-production

Date of Test : 29th, 30th September, 2015

Test Result : **PASS**

- The results in this report are applicable only to the equipment tested.
- This report shall not be reproduced except in full without written acceptance of ISHIKAWA Co., Ltd.

Signature: 
Hironori Tanobka
General Manager

Table of Contents

1. Summary of Test	3
2. Equipment under Test.....	4
3. Configuration of Equipment	6
4. Conducted Emission at Mains Port	8
5. Radiated Emission	11
6. Photographs.....	19
7. Laboratory Description.....	23

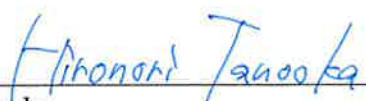

1. Summary of Test

1.1. Test Standard

FCC Part15 SubpartB (§ 15.107, § 15.109) ClassA

1.2. List of Applied Test to the EUT

Test Item	Test Method	Test
Conducted Emission at Mains Port	ANSI C63.4:2003	Applied
Radiated Emission	ANSI C63.4:2003	Applied

1.3. Test Procedure

Test Item	Test Procedure	Internal Test Procedure
Conducted Emission at Mains Port	ANSI C63.4:2003 / Clause 7	IT04-P005 Rev. 3.06
Radiated Emission	ANSI C63.4:2003 / Clause 8	IT04-P007 Rev. 2.07 IT04-P009 Rev. 3.08

2. Equipment under Test

2.1. EUT Information

No.	EUT	Manufacturer	Model No.	Serial No.	FCC ID / DoC
A	CMOS CAMERA	JAI CORPORATION	SP-5000M-USB	β 2 000005	None

Note : The EUT was tested as tabletop.

Internal Max. Frequency : 2.5 GHz

EUT Clock Frequency	CPU Oscillator	Clock Frequency	Name of Board	Note
	80 MHz	2.5 GHz	MAIN Board	—

Power Rating	
	DC 12 V, 6.24 W

Port(s)	Connector Type	Connector Pin
Ethernet	ZX360D-B-10P	10 Pins
DC IN/TRIGGER	HR-10A-10R-12PB(72)	12 Pins

Dimensions of the EUT	Width (mm)	Depth (mm)	Height (mm)
	62.0	48.0	62.0

Weight of the EUT	Weight (g)
	255



2.2. Operating Mode

· Continuous Mode

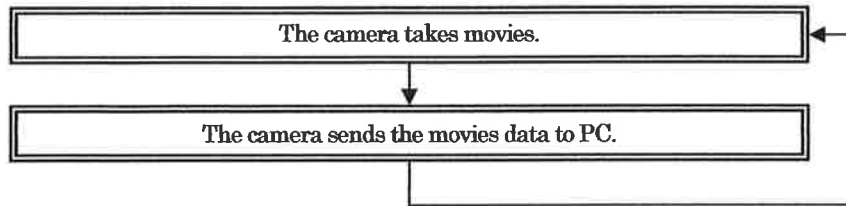

3. Configuration of Equipment

3.1. Peripherals used

No.	Equipment	Manufacturer	Model No.	Serial No.	FCC ID / DoC
B	LENS	RICOH	12.5mm 1:1.8D	139574	None
C	Power Supply	TAKASAGO	KX-100L	451000120584	None
D	LCD Monitor	DELL	2007FPb	CN-0CC147-46633-68I-0LFL	DoC
E	Personal Computer	JAI CORPORATION	JAI-QA-PC	None	None
F	Keyboard	DELL	SK-8110	07N247	DoC
G	Mouse	DELL	MO56UOA	F0B04K4W	DoC

3.2. Cables used

AC Power Cable

No.	Cable(s) Name	Length (m)	Shielding	Ferrite Core	Comment
6	AC Power Cable for Power Supply	1.5	Unshielded	None	—
7	AC Power Cable for Personal Computer	1.5	Unshielded	None	—
8	AC Power Cable for LCD Monitor	1.5	Unshielded	None	—

DC Power Cable

No.	Cable(s) Name	Length (m)	Shielding	Ferrite Core	Comment
2	DC Power Cable for Camera	10.0	Shielded	None	—

Interface Cable

No.	Cable(s) Name	Length (m)	Shielding	Ferrite Core	Comment
1	USB Cable	7.0	Shielded	None	—
3	Monitor Cable	1.8	Shielded	Fixed × 2	Refer to Note
4	Keyboard Cable	2.0	Shielded	None	—
5	Mouse Cable	1.8	Shielded	None	—

Note: The fixed ferrite core is attached to the peripheral.

3.3. System Configuration

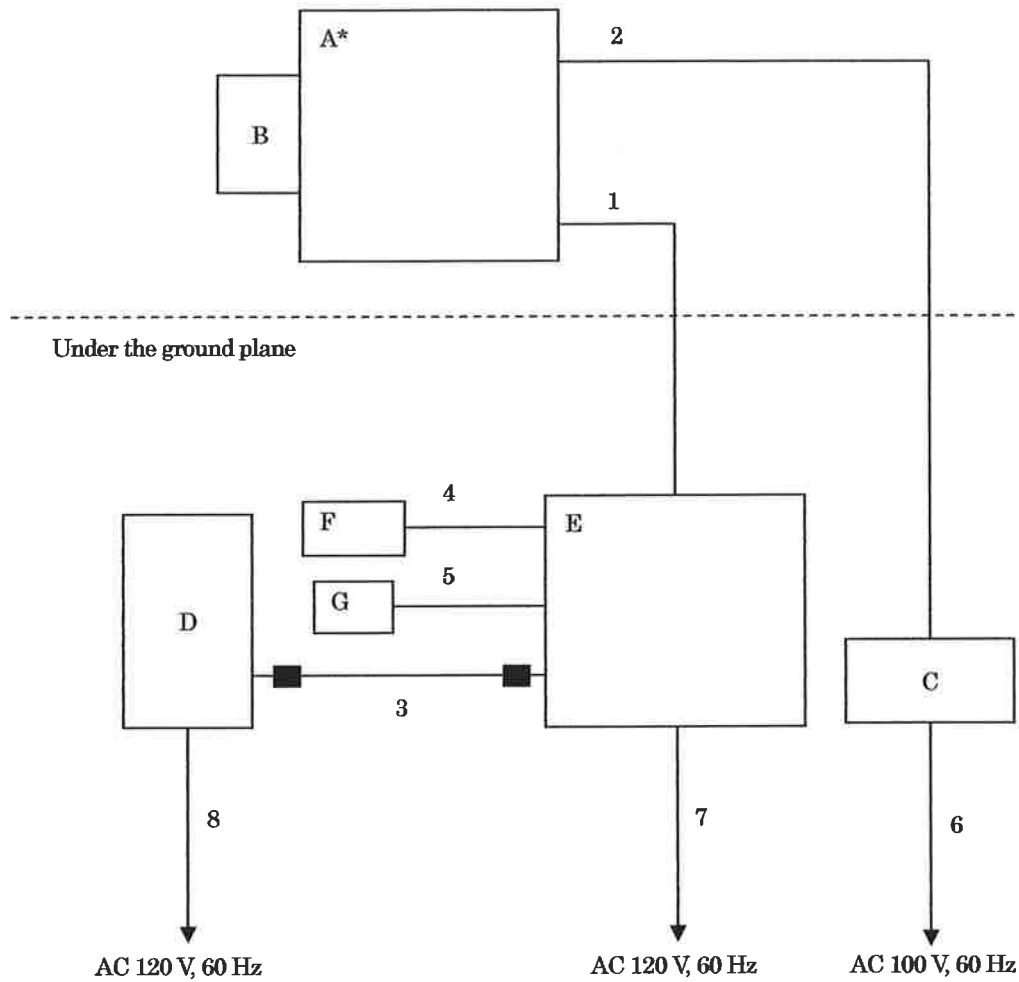

* : EUT

■ : Ferrite Core

4. Conducted Emission at Mains Port

4.1. Measurement Procedure

4.1.1. Test Receiver Condition

Detector: Quasi-peak and Average
Bandwidth: 9 kHz

4.1.2. Frequency range

0.15 MHz – 30 MHz

4.1.3. Vertical Metal Reference Plane

The plane was placed 0.4 m horizontally away from the EUT.

4.1.4. Line Impedance Stabilizing Network (LISN)

50 Ω / 50 μ H
LISN for the EUT was placed 0.8 m away from the EUT.
LISN for the peripherals was terminated in 50 Ω .

4.1.5. Reported Emissions

At least the 6 points corresponding to the highest disturbance are reported.
A preliminary test was carried out while varying cable positions within typical arrangements to determine the maximum or near-maximum emission level.

4.1.6. Test Configuration

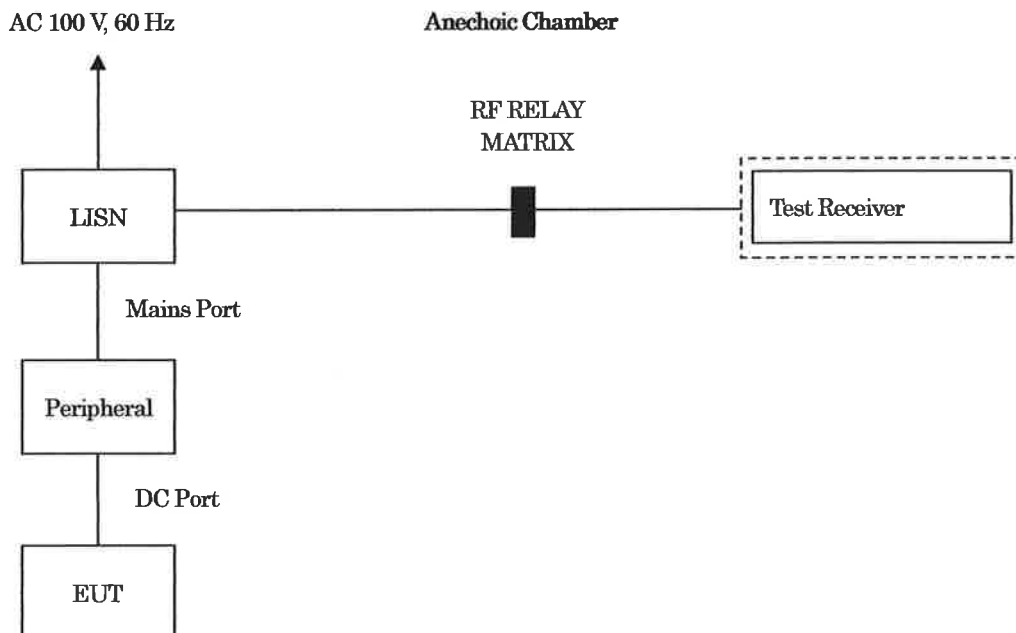

4.2. Test Equipment

Equipment	Manufacturer	Model No.	Serial or ID No.	Calibration Due
Test Receiver	Rohde & Schwarz	ESU26	100299	Apr-2016
RF RELAY MATRIX	tsj	RFMI2A2M	03153	Aug-2016
LISN for EUT	Kyoritsu	KNW-242C	8-1673-1	Feb-2016
Attenuator for LISN (KNW-242C)	TAMAGAWA	CFA-01	2626	Feb-2016
LISN for peripherals	Kyoritsu	KNW-407	8-901-12	Jan-2016
Terminator for LISN	JFW	50T-001-BNC	151	Jun-2016
Coaxial Cable (1)	SUHNER	RG400	258	Aug-2016
Coaxial Cable (2)	SUHNER	S04272B	376	Aug-2016
Coaxial Cable (3)	SUHNER	RG214HF	615	Aug-2016
Coaxial Cable (4)	SUHNER	SF106	32551/6	Aug-2016
Software	tsj	TEPTO-DV/CE	v1.90.0098	N/A

Note 1: All testing equipment is calibrated with measuring equipment which are traceable to national or international standards.

4.3. Sample Calculation

Conducted Emission at Mains Port Class A Limit*

Frequency Range (MHz)	Limit (dBuV)	
	QP	AV
0.15 – 0.5	79	66
0.5 – 30	73	60

*: The lower limits apply at the transition frequency.

• Example @ 1.41298 MHz for Continuous Mode

$$\begin{array}{rcl}
 \text{Disturbance Level} & = & \text{Reading} & 44.0 & \text{dBuV} \\
 & + & \text{Correction Factor*} & + & 10.3 & \text{dB} \\
 & & & = & 54.3 & \text{dBuV}
 \end{array}$$

$$\begin{array}{rcl}
 \text{Margin} & = & \text{Limit} & 60.0 & \text{dBuV} \\
 & - & \text{Disturbance Level} & - & 54.3 & \text{dBuV} \\
 & & & = & 5.7 & \text{dB}
 \end{array}$$

*: Correction Factor = Cable Loss (dB) + LISN Factor (dB)

Note: The sample calculation above is the minimum margin at the measuring frequency.

4.4. Uncertainty

Expanded uncertainties were calculated with a coverage factor $k = 2$ for Conducted Emission.

+2.66 dB / -2.77 dB

ISHIKAWA Co., Ltd. EMC Laboratory
2-3-18, Namamugi, Tsurumi-ku, Yokohama, Kanagawa 230-0052 Japan
TEL: +81 45-500-2255 FAX: +81 45-500-2256

4.5. Test Data

Conducted Emission

10m A/C
Date : 2015/09/30 14:13

Model Name : CMOS Camera
Model No. : SP-5000M-USB
Serial No. : β 2 000005
Test Condition : Continuous Mode

Data No. : IE1509-013A-11
Power Supply : AC 100V, 60Hz
Temp/Humi : 24°C / 30%
Operator : A. Piroddi

Memo :

LIMIT : FCC Part15 SubpartB ClassA (QP)
FCC Part15 SubpartB ClassA (AV)

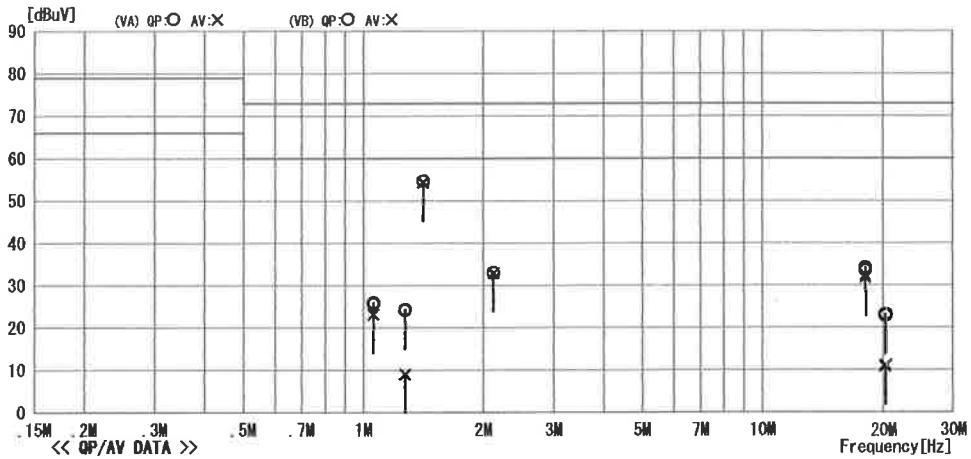

No	Freq. [MHz]	Reading Level		C Fac	Results		Limit		Margin		Phase
		QP [dBuV]	AV [dBuV]		QP [dBuV]	AV [dBuV]	QP [dBuV]	AV [dBuV]	QP [dB]	AV [dB]	
1	1.05976	15.3	12.8	10.3	25.6	23.1	73.0	60.0	47.4	36.9	VA
2	1.05978	15.7	12.9	10.3	26.0	23.2	73.0	60.0	47.0	36.8	VB
3	1.27088	14.0	-1.2	10.3	24.3	9.1	73.0	60.0	48.7	50.9	VA
4	1.27168	13.8	-1.3	10.3	24.1	9.0	73.0	60.0	48.9	51.0	VB
5	1.41296	44.3	44.0	10.3	54.6	54.3	73.0	60.0	18.4	5.7	VB
6	1.41321	44.3	43.9	10.3	54.6	54.2	73.0	60.0	18.4	5.8	VA
7	2.11904	22.5	22.5	10.4	32.9	32.9	73.0	60.0	40.1	27.1	VA
8	2.11956	22.6	22.5	10.4	33.0	32.9	73.0	60.0	40.0	27.1	VB
9	18.06152	23.0	21.3	11.1	34.1	32.4	73.0	60.0	38.9	27.6	VA
10	18.06160	22.5	20.8	11.0	33.5	31.8	73.0	60.0	39.5	28.2	VB
11	20.26745	11.6	-0.4	11.2	22.8	10.8	73.0	60.0	50.2	49.2	VB
12	20.26753	11.9	-0.1	11.3	23.2	11.2	73.0	60.0	49.8	48.8	VA

5. Radiated Emission

5.1. Measurement Procedure

5.1.1. Test Receiver Condition

Below 1000 MHz:	Detector: Quasi-peak Bandwidth: 120 kHz
Above 1000 MHz:	Detector: Average, Peak Bandwidth: 1 MHz

5.1.2. Frequency Range

30 MHz – 16000 MHz

5.1.3. Measuring Distance

Below 1000 MHz:	10 m
Above 1000 MHz:	3 m

5.1.4. Turn Table

Rotated 0 to 360 degrees

5.1.5. Antenna Position

Antenna height:	1 m to 4 m
Polarization	Horizontal and Vertical

5.1.6. Reported Emissions

At least the 6 points corresponding to the highest disturbance are reported.

5.1.7. Test Configuration

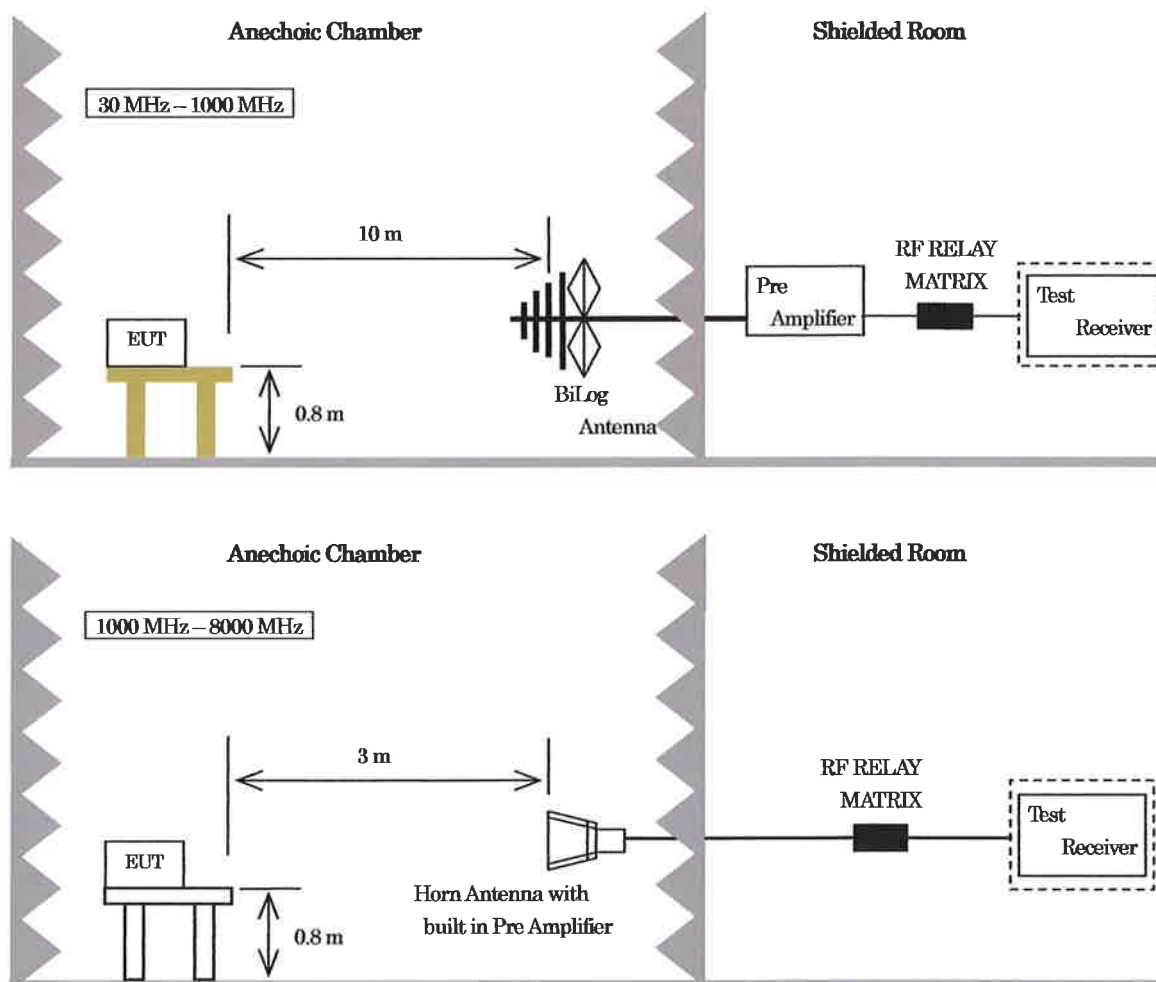

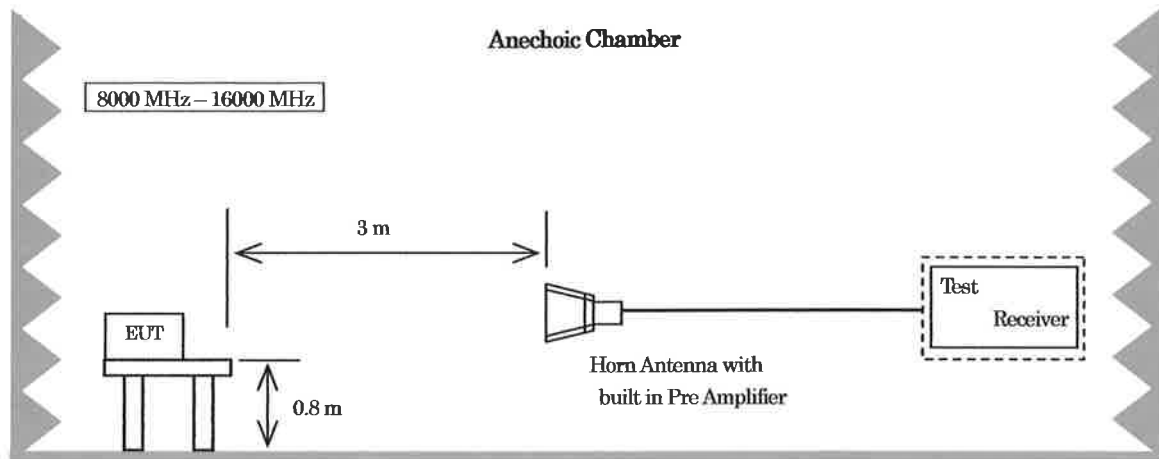

5.2. Test Equipment

Equipment	Manufacturer	Model No.	Serial or ID No.	Calibration Due
Test Receiver	Rohde & Schwarz	ESU26	100299	Apr-2016
Pre Amplifier	Sonoma	310N	243232	Aug-2016
RF RELAY MATRIX	tsj	RFMI2A2M	03153	Aug-2016
Bilog Antenna	Schaffner	CBL6112B	2900	May-2016
Horn Antenna	EMCO	3115	8912-3303	Dec-2015
Pre Amplifier for Horn Antenna	tsj	MLA-0108AD-39	005	Dec-2015
Horn Antenna with built in Pre Amplifier	ETS·LINDGREN	3161-04EJ338	00040843	Jan-2017
Attenuator	JFW	50HF-003N	003	Aug-2016
Attenuator	JFW	50HF-003N	004	Aug-2016
Coaxial Cable (1)	SUHNER	RG400	259	Aug-2016
Coaxial Cable (2)	SUHNER	RG400	260	Aug-2016
Coaxial Cable (3)	SUHNER	S04272B	612	Aug-2016
Coaxial Cable (4)	SUHNER	S04272B	376	Aug-2016
Coaxial Cable (5)	SUHNER	SF106	32550/6	Aug-2016
Coaxial Cable (6)	SUHNER	SF104EA	15250/4EA	Aug-2016
Coaxial Cable (7)	SUHNER	SF104EA	10450/4EA	Aug-2016
Software	tsj	TEPTO-DV/RE	v1.90.0098	N/A

Note 1: All testing equipment is calibrated with measuring equipment which are traceable to national or international standards.

Note 2: The pre-amplifier is connected to the horn antenna. (3115)

5.3. Sample Calculation

Radiated Emission Class A Limit*

Frequency Range (MHz)	Limit(dBuV/m)
	Quasi Peak
30 – 88	39.0
88 – 216	43.5
216 – 960	46.4
960 – 1000	49.5

*: The lower limits apply at the transition frequency.

Radiated Emission Class A Limit

Frequency range (MHz)	Limit(dBuV/m)	
	Average	Peak
Above 1000	59.5	79.5

• Example @ 999.994 MHz for Continuous Mode

Disturbance Level	=	Reading		32.8	dBuV
	+	Correction Factor*	+	3.3	dB/m
			=	36.1	dBuV/m

Margin	=	Limit		49.5	dBuV/m
	-	Disturbance Level	-	36.1	dBuV/m
			=	13.4	dB

*: Correction Factor = Antenna Factor (dB/m) + Cable Loss (dB) [include 3dB attenuator×2] – Pre Amplifier Gain (dB)

Note: The sample calculation above is the minimum margin at the measuring frequency.

5.4. Uncertainty

Expanded uncertainties were calculated with a coverage factor $k = 2$ for Radiated Emission.

+ 4.06 dB / - 4.32 dB

ISHIKAWA Co., Ltd. EMC Laboratory
2-3-18, Namamugi, Tsurumi-ku, Yokohama, Kanagawa 230-0052 Japan
TEL: +81 45-500-2255 FAX: +81 45-500-2256

5.5. Test Data

Radiated Emission

10m A/C
Date : 2015/09/29 09:31

Model Name : CMOS Camera
Model No. : SP-5000M-USB
Serial No. : B2 000005
Test Condition : Continuous Mode

Data No. : IE1509-012A-05
Power Supply : DC 12V
Temp./Humi. : 24°C / 55%
Operator : A. Piroddi

Memo :

LIMIT : FCC Part15 SubpartB ClassA(10m)

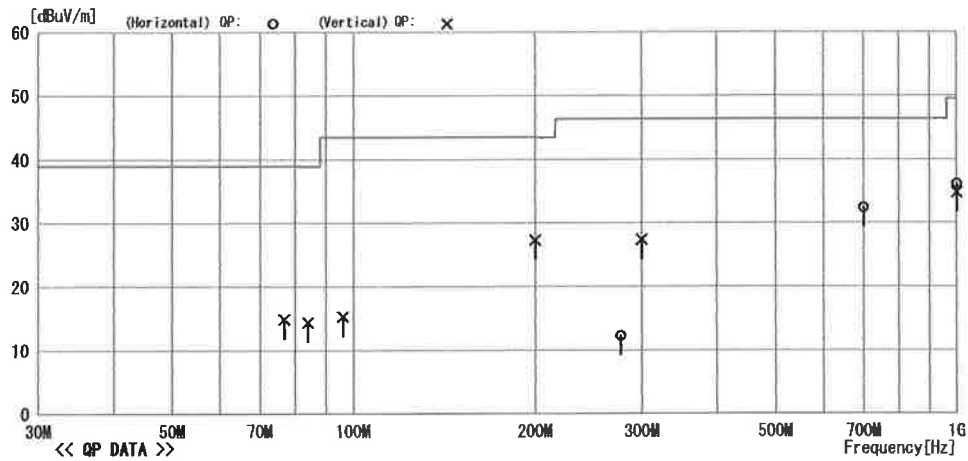

No	Freq. [MHz]	Reading [dBuV]	Ant. Fac [dB/m]	Loss [dB]	Gain [dB]	Result [dBuV/m]	Limit [dBuV/m]	Margin [dB]	Pola. [H/V]	Height [cm]	Angle [deg]	Ant Type
1	76.800	32.3	6.7	7.5	31.6	14.9	39.0	24.1	Vert.	191	0	BLG
2	84.087	30.6	7.8	7.6	31.6	14.4	39.0	24.6	Vert.	115	0	BLG
3	96.102	29.1	10.1	7.7	31.6	15.3	43.5	28.2	Vert.	249	0	BLG
4	199.999	41.0	9.2	8.7	31.6	27.3	43.5	16.2	Vert.	100	23	BLG
5	276.915	21.8	12.8	9.3	31.6	12.3	46.4	34.1	Hori.	100	0	BLG
6	299.998	36.3	13.2	9.5	31.6	27.4	46.4	19.0	Vert.	100	355	BLG
7	699.996	33.6	19.0	11.6	31.6	32.4	46.4	14.0	Hori.	142	63	BLG
8	999.994	32.8	21.2	12.8	30.7	36.1	49.5	13.4	Hori.	100	51	BLG
9	999.994	31.5	21.2	12.8	30.7	34.8	49.5	14.7	Vert.	216	0	BLG

Radiated Emission

10m A/C
 Date : 2015/09/29 15:07

Model Name : CMOS Camera
 Model No. : SP-5000M-USB
 Serial No. : β 2 000005
 Test Condition : Continuous Mode

Data No. : IE1509-012A-13
 Power Supply : DC 12V
 Temp/Humi : 24°C / 55%
 Operator : A. Piroddi

Memo :

LIMIT : FCC Part15 SubpartB ClassA(3m)Peak

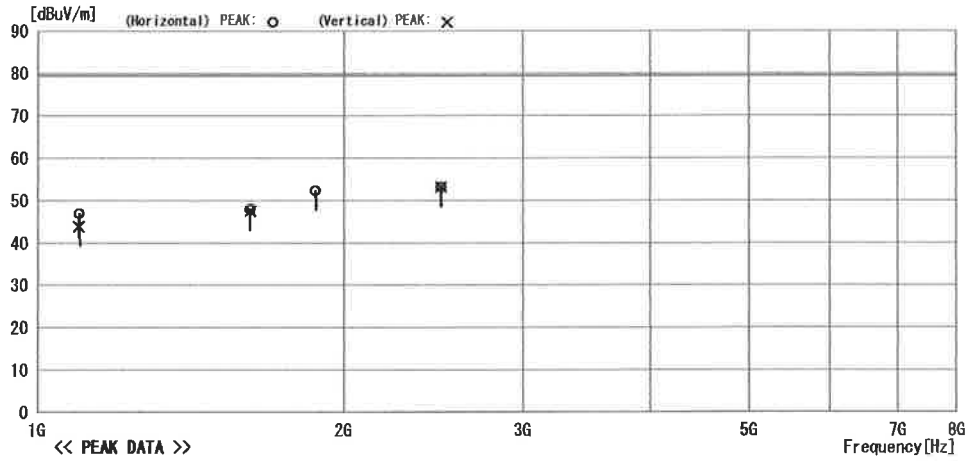

No	Freq.	Reading	Ant. Fac	Loss	Gain	Result	Limit	Margin	Pola.	Height	Angle	Ant
	[MHz]	[dBuV]	[dB/m]	[dB]	[dB]	[dBuV/m]	[dBuV/m]	[dB]	[H/V]	[cm]	[deg]	Type
1	1099.994	55.3	25.7	6.6	40.7	46.9	79.5	32.6	Hori.	268	54	HOR
2	1099.994	52.3	25.7	6.6	40.7	43.9	79.5	35.6	Vert.	109	161	HOR
3	1620.020	54.9	26.0	8.0	41.0	47.9	79.5	31.6	Hori.	141	133	HOR
4	1620.020	54.5	26.0	8.0	41.0	47.5	79.5	32.0	Vert.	104	180	HOR
5	1876.900	57.2	27.4	8.7	41.0	52.3	79.5	27.2	Hori.	129	243	HOR
6	2489.923	55.7	28.7	10.0	41.3	53.1	79.5	26.4	Hori.	100	115	HOR
7	2489.923	55.7	28.7	10.0	41.3	53.1	79.5	26.4	Vert.	100	148	HOR



Radiated Emission

10m A/C
 Date : 2015/09/29 15:07

Model Name : CMOS Camera
 Model No. : SP-5000M-USB
 Serial No. : B2 000005
 Test Condition : Continuous Mode

Data No. : IE1509-012A-14
 Power Supply : DC 12V
 Temp/Humi : 24°C / 55%
 Operator : A. Piroddi

Memo :

LIMIT : FCC Part15 SubpartB ClassA(3m)

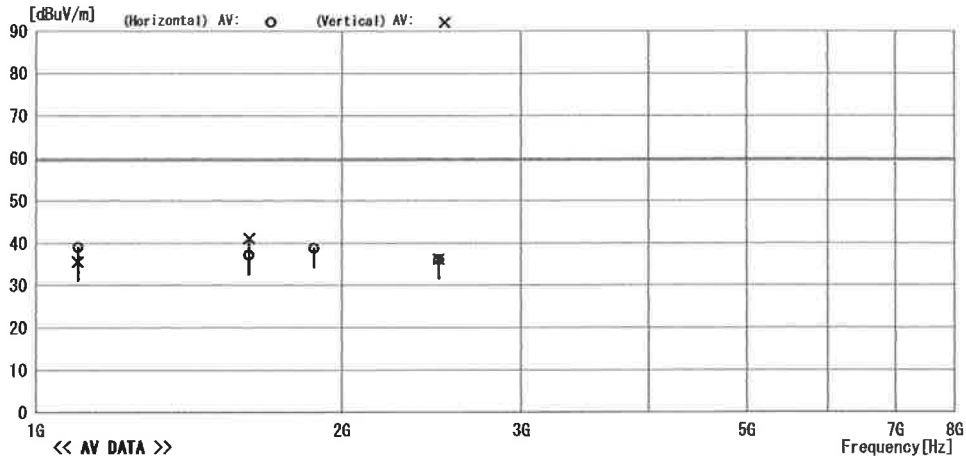

No	Freq.	Reading	Ant. Fac	Loss	Gain	Result	Limit	Margin	Pola.	Height	Angle	Ant
	[MHz]	[dBuV]	[dB/m]	[dB]	[dB]	[dBuV/m]	[dBuV/m]	[dB]	[H/V]	[cm]	[deg]	Type
1	1099.994	47.4	25.7	6.6	40.7	39.0	59.5	20.5	Hori.	268	54	HOR
2	1099.994	44.0	25.7	6.6	40.7	35.6	59.5	23.9	Vert.	109	161	HOR
3	1620.020	44.1	26.0	8.0	41.0	37.1	59.5	22.4	Hori.	141	133	HOR
4	1620.020	48.1	26.0	8.0	41.0	41.1	59.5	18.4	Vert.	104	180	HOR
5	1876.900	43.7	27.4	8.7	41.0	38.8	59.5	20.7	Hori.	129	243	HOR
6	2489.923	38.7	28.7	10.0	41.3	36.1	59.5	23.4	Hori.	100	115	HOR
7	2489.923	38.8	28.7	10.0	41.3	36.2	59.5	23.3	Vert.	100	148	HOR

Radiated Emission

Date : 2015/09/30 10:46 ^{10m A/C}

Model Name : CMOS Camera	Data No. : IE1509-013A-03
Model No. : SP-5000M-USB	Power Supply : DC 12V
Serial No. : β 2 000005	Temp/Humi : 24°C / 30%
Test Condition : Continuous Mode	Operator : A. Piroddi

Memo :

LIMIT : FCC Part15 SubpartB ClassA(3m)Peak

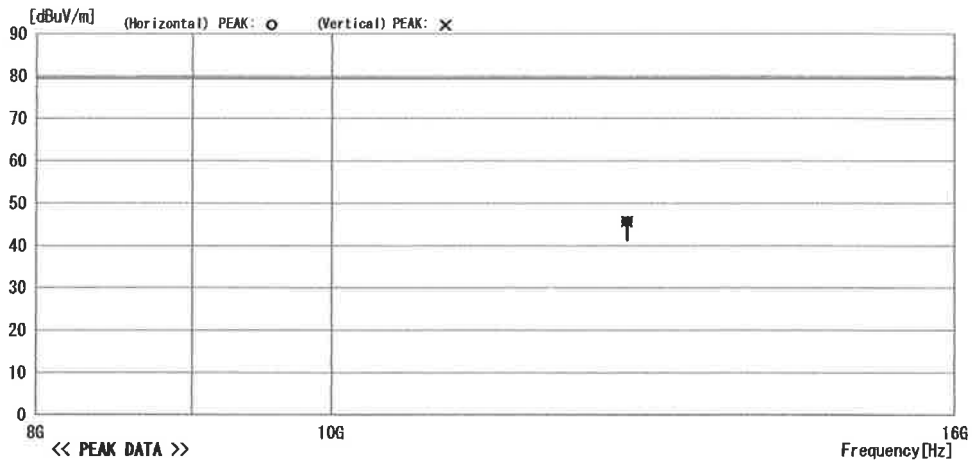

No	Freq.	Reading	Ant. Fac	Loss	Gain	Result	Limit	Margin	Pola.	Height	Angle	Ant.
	[Hz]	[dBuV]	[dB/m]	[dB]	[dB]	[dBuV/m]	[dBuV/m]	[dB]	[H/V]	[cm]	[deg]	Type
1	12500.000	41.5	-1.1	5.3	0.0	45.7	79.5	33.8	Hori.	100	183	HOR
2	12500.000	41.5	-1.1	5.3	0.0	45.7	79.5	33.8	Vert.	100	0	HOR

Radiated Emission

10m A/C
 Date : 2015/09/30 10:46

Model Name : CMOS Camera
 Model No. : SP-5000M-USB
 Serial No. : B2 000005
 Test Condition : Continuous Mode

Data No. : IE1509-013A-04
 Power Supply : DC 12V
 Temp/Humi : 24°C / 30%
 Operator : A. Piroddi

Memo :

LIMIT : FCC Part15 SubpartB ClassA(3m)

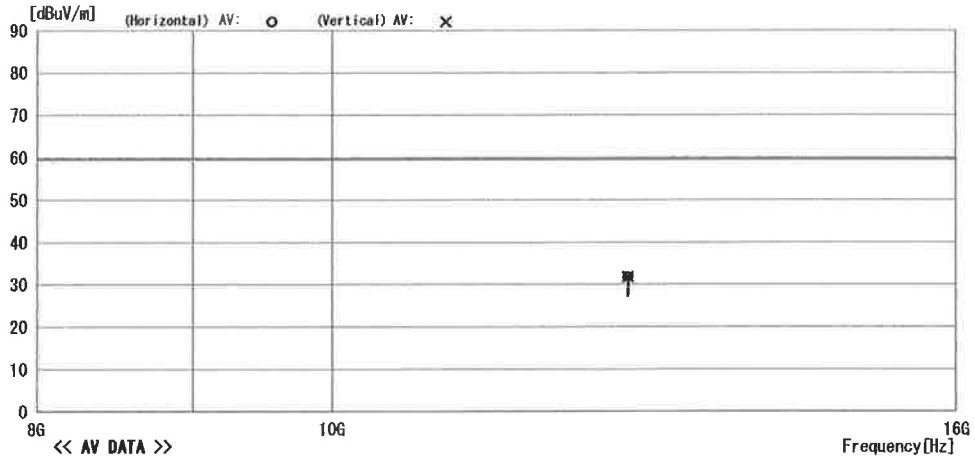

No	Freq. [MHz]	Reading [dBuV]	Ant. Fac [dB/m]	Loss [dB]	Gain [dB]	Result [dBuV/m]	Limit [dBuV/m]	Margin [dB]	Pola. [H/V]	Height [cm]	Angle [deg]	Ant Type
1	12500.000	27.6	-1.1	5.3	0.0	31.8	59.5	27.7	Hori.	100	183	HOR
2	12500.000	27.6	-1.1	5.3	0.0	31.8	59.5	27.7	Vert.	100	0	HOR



6. Photographs

6.1. Conducted Emission at Mains Port



6.2. Radiated Emission

• 30 MHz – 1000 MHz





• 1000 MHz – 8000 MHz





• 8000 MHz – 16000 MHz

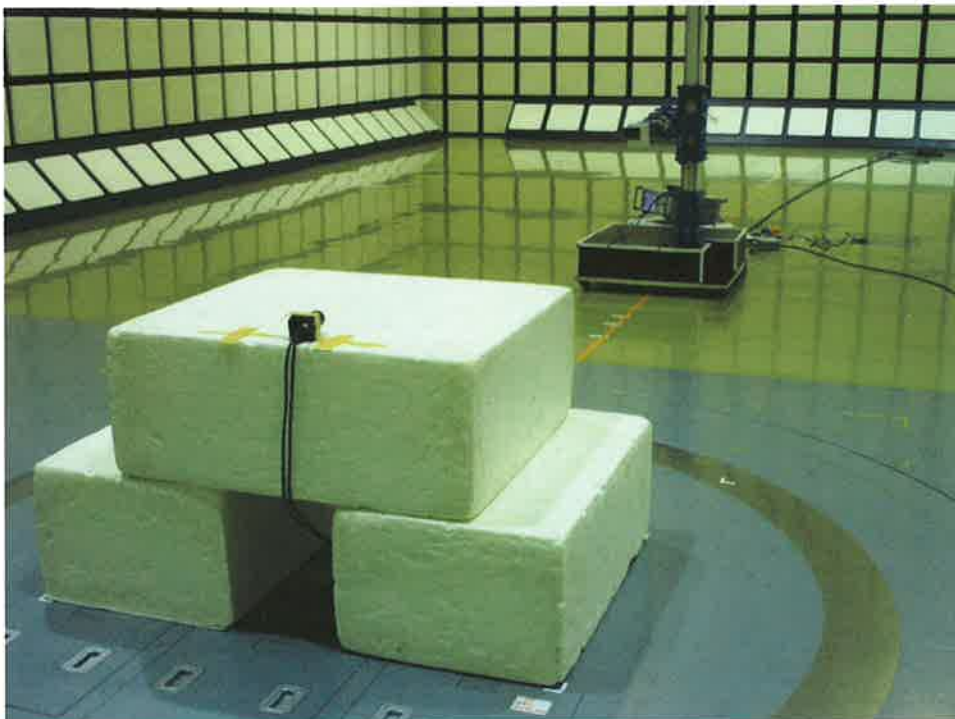

ISHIKAWA Co., Ltd. EMC Laboratory
2-3-18, Namamugi, Tsurumi-ku, Yokohama, Kanagawa 230-0052 Japan
TEL: +81 45-500-2255 FAX: +81 45-500-2256

7. Laboratory Description

7.1. Location

ISHIKAWA Co., Ltd. EMC Laboratory
2-3-18, Namamugi, Tsurumi-ku, Yokohama, Kanagawa 230-0052 Japan
TEL: +81 45-500-2255 FAX: +81 45-500-2256

7.2. Laboratory Equipment

Site Name	Shielded room Volume	Turn table	Weight proof
Shielded room No. 1	4.9m × 2.9m × 2.8m	-----	-----
Shielded room No. 2	8m × 5m × 2.8m	-----	-----
10m Anechoic chamber	21.5m × 13.5m × 8.9m	4m diameter	3,000 kg
3m Anechoic chamber	9m × 6m × 5.7m	2m diameter	500 kg

7.3. Laboratory Filing or Certificate Information

7.3.1. VCCI Site Registration pursuant to V-5

Site Name	Registration No.	Expiry Date
ISHIKAWA Co., Ltd.	A-0105	July 14, 2017

7.3.2. FCC Site Filing pursuant to CFR 47 § 2.948

Site Name	Test Firm Registration No.	Expiry Date
ISHIKAWA Co., Ltd.	743690	July 5, 2017

7.3.3. VLAC Accreditation

Site Name	Accreditation No.	Expiry Date
ISHIKAWA Co., Ltd. EMC Laboratory	VLAC-025	July 14, 2017

7.3.4. TÜV Rheinland Certificate of Appointment Laboratory

Site Name	Registration No.	Expiry Date
ISHIKAWA Co., Ltd. EMC Laboratory	UA50060145-0011	May 31, 2016

7.3.5. Industry Canada site filing pursuant to RSS-Gen

Site Name	File No.	Expiry Date
10m Anechoic chamber	5804A-1	August 19, 2018
3m Anechoic chamber	5804A-2	August 19, 2018