



Test Report

Test Report No. IE1609-008T2
Date of Issue: 29th September, 2016

FCC Part 15 Subpart B

Radio Frequency Devices

Applicant Information	
Name of Applicant	: JAI CORPORATION
Address	: 10-35 Sakae-Chou, Kanagawa-Ku, Yokohama, Kanagawa, 221-0052 Japan
Telephone	: +81 45-440-0165
Facsimile	: +81 45-440-0167
Equipment under Test (EUT)	: CMOS AREA SCAN CAMERA
Model Number	: GO-5101C-PMCL
Serial Number	: a0003
EUT Condition	: Pre-Production

Date of Test : 13th September, 2016

Test Result : **PASS**

- The results in this report are applicable only to the equipment tested.
- This report shall not be reproduced except in full without written acceptance of ISHIKAWA Co., Ltd.

Signature: Hironori Tanooka
Hironori Tanooka
Director



Table of Contents

1. Summary of Test	3
2. Equipment under Test.....	4
3. Configuration of Equipment	5
4. Conducted Emission at Mains Port	7
5. Radiated Emission	10
6. Photographs.....	16
7. Laboratory Description.....	19

1. Summary of Test

1.1. Test Standard

FCC Part15 SubpartB (§ 15.107, § 15.109) ClassB

1.2. List of Applied Test to the EUT

Test Item	Test Method	Test
Conducted Emission at Mains Port	ANSI C63.4:2014	Applied
Radiated Emission	ANSI C63.4:2014	Applied

1.3. Test Procedure

Test Item	Test Procedure	Internal Test Procedure
Conducted Emission at Mains Port	ANSI C63.4:2014 / Clause 7	IT04-P005 Rev. 3.06
Radiated Emission	ANSI C63.4:2014 / Clause 8	IT04-P007 Rev. 3.00 IT04-P009 Rev. 4.00

2. Equipment under Test

2.1. EUT Information

No.	EUT	Manufacturer	Model No.	Serial No.	FCC ID / DoC
A	CMOS AREA SCAN CAMERA	JAI CORPORATION	GO-5101C-PMCL	α 0003	None

Note: The EUT was tested as tabletop.

Internal Max. Frequency : 297 MHz

EUT Clock Frequency	CPU Oscillator	Clock Frequency	Name of Board	Note
	74.25 MHz	297 MHz	Main Board	—

Power Rating :
Input DC 12-24 V, 300 mA

Port(s)	Connector Type	Connector Pin	Note
Mini Camera Link Connector	SDR	26 Pins	Camera Link
Mini Camera Link Connector	SDR	26 Pins	Camera Link

Dimensions of the EUT	Width (mm)	Depth (mm)	Height (mm)
	29.0	41.5	29.0

Weight of the EUT : Weight (kg)
0.460

2.2. Variation the product family

No.	Model No.	Dimension	Weight	Power Rating	Note
EUT	GO-5101C-PMCL	29.0mm(W)×41.5mm(D)×29.0mm(H)	0.460kg	DC 12-24 V, 300 mA	—
EUT*	GO-5101C-PMCL-NF	29.0mm(W)×41.5mm(D)×29.0mm(H)	0.460kg	DC 12-24 V, 300 mA	Refer to Note

Note: GO-5101C-PMCL and GO-5101C-PMCL-NF is the same except for the presence or absence of the IR Cut Filter (CM-500S).

2.3. Operating Mode

• Continuous Mode

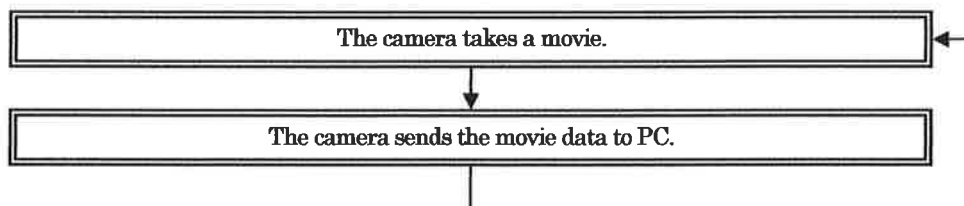

3. Configuration of Equipment

3.1. Peripherals used

No.	Equipment	Manufacturer	Model No.	Serial No.	FCCID / DoC
B	LENS	FUJINON	HF12.5HA-1B	None	None
C	LCD MONITOR	EIZO	0FTD1504	38807090	DoC
D	Personal Computer	DELL	Precision Tower 5810	GRCPB22	DoC
E	Frame Grabber Board	Teledyne DALSA	OR-Y4C0-XPX00	S0058007	None
F	KEYBOARD	DELL	SK-8120	CN-0DH939-71616 -48C-0554-A00	DoC
G	MOUSE	Logicool	M-R0042	1449LZ0TJ888	None

3.2. Cables used

AC Power Cable

No.	Cable(s) Name	Length (m)	Shielding	Ferrite Core	Comment
4	AC Power Cable for Personal Computer	1.5	Unshielded	None	—
5	AC Power Cable for LCD MONITOR	1.5	Unshielded	None	—

Interface Cable

No.	Cable(s) Name	Length (m)	Shielding	Ferrite Core	Comment
1	Camera Link PoCL Mini Cable	10.0	Shielded	None	—
2	Camera Link PoCL Mini Cable	10.0	Shielded	None	—
3	LCD MONITOR Cable	1.0	Shielded	Fixed × 2	Refer to Note
6	KEYBOARD Cable	2.0	Shielded	None	—

Note: The fixed ferrite core is attached to the peripheral.

3.3. System Configuration

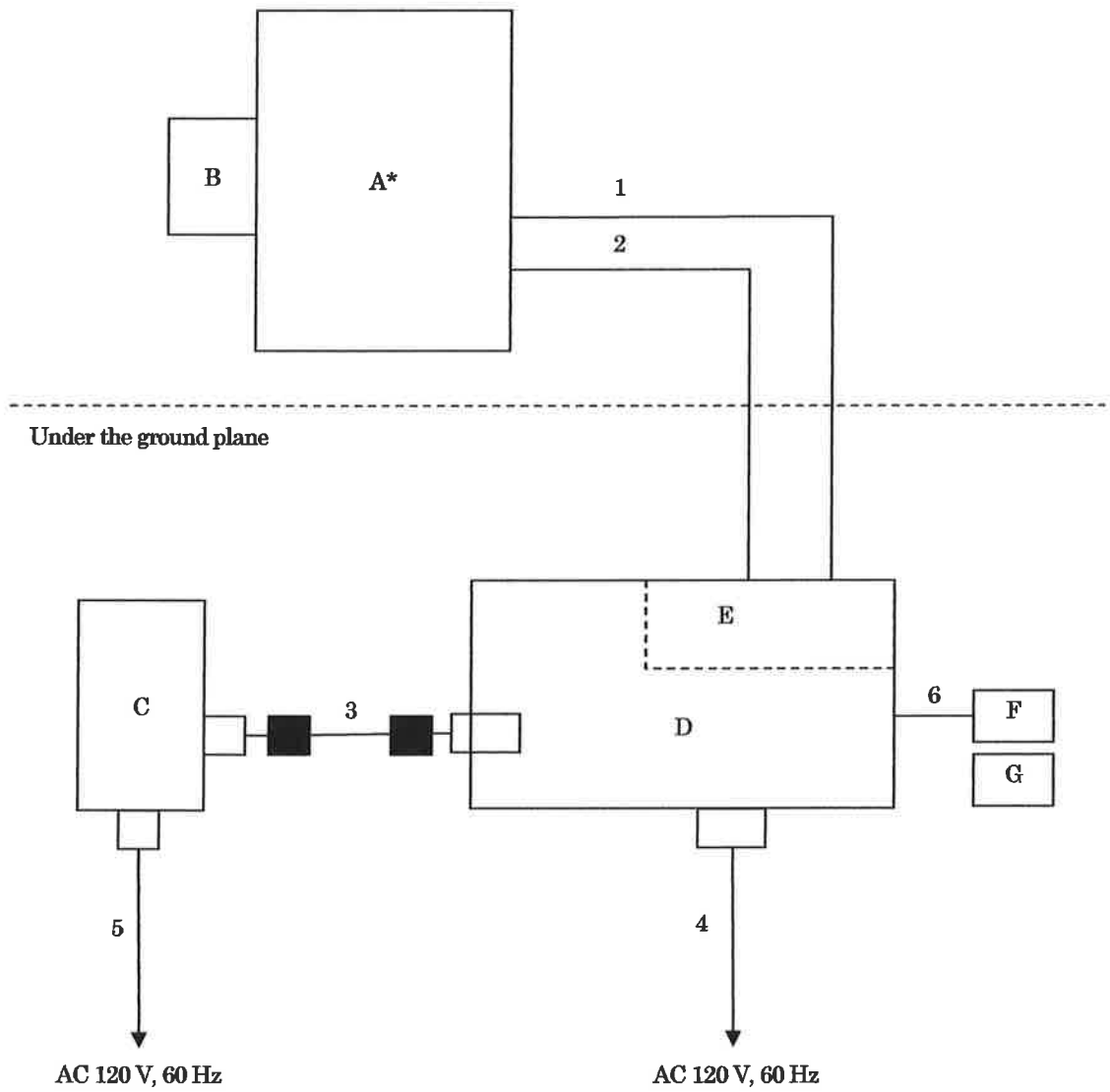

* : EUT
■ : Ferrite Core

4. Conducted Emission at Mains Port

4.1. Measurement Procedure

4.1.1. Test Receiver Condition

Detector: Quasi-peak and Average
Bandwidth: 9 kHz

4.1.2. Frequency range

0.15 MHz – 30 MHz

4.1.3. Vertical Metal Reference Plane

The plane was placed 0.4 m horizontally away from the EUT.

4.1.4. Line Impedance Stabilizing Network (LISN)

50 Ω / 50 μ H

LISN for the EUT was placed 0.8 m away from the EUT.

LISN for the peripherals was terminated in 50 Ω .

4.1.5. Reported Emissions

At least the 6 points corresponding to the highest disturbance are reported.

A preliminary test was carried out while varying cable positions within typical arrangements to determine the maximum or near-maximum emission level.

4.1.6. Test Configuration

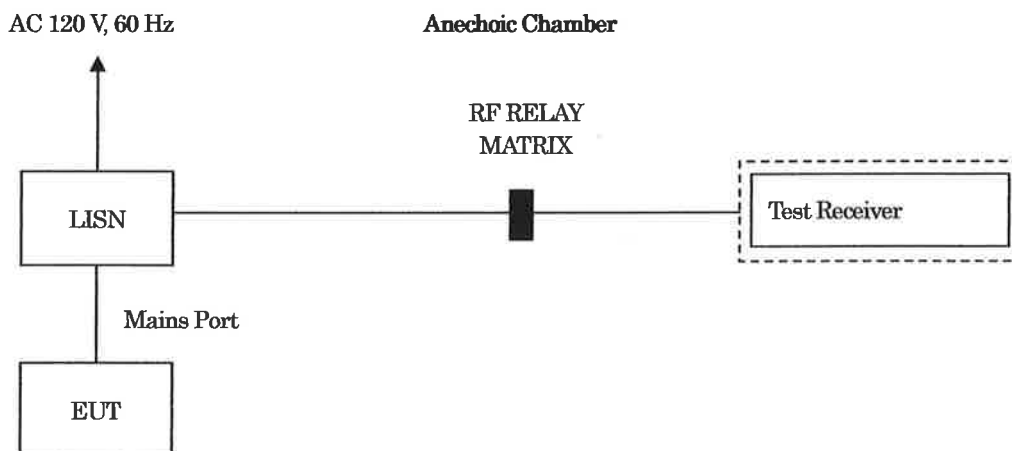

4.2. Test Equipment

Equipment	Manufacturer	Model No.	Serial or ID No.	Calibration Due
Test Receiver	Rohde & Schwarz	ESU26	100299	Apr-2017
RF RELAY MATRIX	tsj	RFMT2A2M	03153	Aug-2017
LISN for EUT	Kyoritsu	KNW-242C	8-1673-1	Feb-2017
Attenuator for LISN (KNW-242C)	PASTERNAK	PE7049-10	331	Feb-2017
LISN for peripherals	Kyoritsu	KNW-407	8-901-12	Jan-2017
Terminator for LISN	JFW	50T-001-BNC	151	Jun-2017
Coaxial Cable (1)	SUHNER	RG400	258	Aug-2017
Coaxial Cable (2)	SUHNER	S04272B	376	Aug-2017
Coaxial Cable (3)	SUHNER	RG214HF	615	Aug-2017
Coaxial Cable (4)	SUHNER	SF106	32551/6	Aug-2017
Software	tsj	TEPTO-DV/CE	v1.90.0098	N/A

Note 1: All testing equipment is calibrated with measuring equipment which are traceable to national or international standards.

4.3. Sample Calculation

Conducted Emission at Mains Port Class B Limit*

Frequency Range (MHz)	Limit (dBuV)	
	QP	AV
0.15 – 0.5	66 – 56**	56 – 46**
0.5 – 5	56	46
5 – 30	60	50

*: The lower limits apply at the transition frequency.

***: The limit decreases linearly with the logarithm of the frequency.

• Example @ 0.99921 MHz for Continuous Mode

$$\begin{array}{rcl}
 \text{Disturbance Level} & = & \text{Reading} & 30.6 & \text{dBuV} \\
 & + & \text{Correction Factor*} & + & 10.3 & \text{dB} \\
 & & & = & 40.9 & \text{dBuV}
 \end{array}$$

$$\begin{array}{rcl}
 \text{Margin} & = & \text{Limit} & 56.0 & \text{dBuV} \\
 & - & \text{Disturbance Level} & - & 40.9 & \text{dBuV} \\
 & & & = & 15.1 & \text{dB}
 \end{array}$$

*: Correction Factor = Cable Loss (dB) + LISN Factor (dB)

Note: The sample calculation above is the minimum margin at the measuring frequency.

4.4. Uncertainty

Expanded uncertainties were calculated with a coverage factor $k = 2$ for Conducted Emission.

+2.66 dB / -2.77 dB

ISHIKAWA Co., Ltd. EMC Laboratory
2-3-18, Namamugi, Tsurumi-ku, Yokohama, Kanagawa 230-0052 Japan
TEL: +81 45-500-2255 FAX: +81 45-500-2256

4.5. Test Data

Conducted Emission

10m A/C
Date : 2016/09/13 18:04

Model Name : CMOS Area Scan Camera
Model No. : G0-5101C-PWCL
Serial No. : α0003
Test Condition : Continuous Mode
Data No. : IE1609-008A-16
Power Supply : AC 120V, 60Hz
Temp/Humi : 23°C / 58%
Operator : A. Piroddi

Memo :

LIMIT : FCC Part15 SubpartB ClassB (QP)
FCC Part15 SubpartB ClassB (AV)

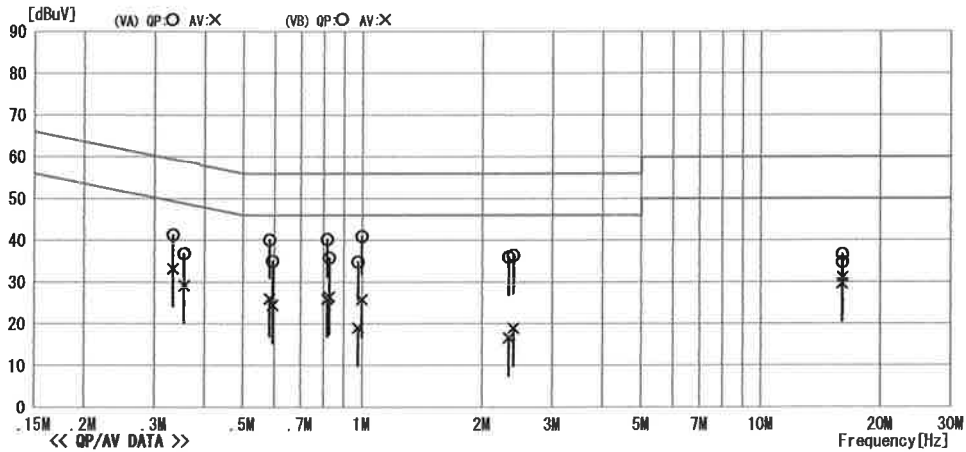

No	Freq. [MHz]	Reading Level		C. Fac [dB]	Results		Limit		Margin		Phase
		QP [dBuV]	AV [dBuV]		QP [dBuV]	AV [dBuV]	QP [dB]	AV [dB]			
1	0.33378	31.1	23.1	10.2	41.3	33.3	59.4	49.4	18.1	16.1	VB
2	0.35630	26.7	19.0	10.2	36.9	29.2	58.8	48.8	21.9	19.6	VA
3	0.58382	29.8	15.7	10.3	40.1	26.0	56.0	46.0	15.9	20.0	VB
4	0.59424	24.7	14.1	10.3	35.0	24.4	56.0	46.0	21.0	21.6	VA
5	0.81739	29.9	15.6	10.3	40.2	25.9	56.0	46.0	15.8	20.1	VB
6	0.82701	25.5	16.1	10.3	35.8	26.4	56.0	46.0	20.2	19.6	VA
7	0.97737	24.5	8.7	10.3	34.8	19.0	56.0	46.0	21.2	27.0	VA
8	0.99821	30.6	15.5	10.3	40.9	25.8	56.0	46.0	15.1	20.2	VB
9	2.33189	25.7	6.2	10.4	36.1	16.6	56.0	46.0	19.9	29.4	VA
10	2.39433	26.1	8.5	10.4	36.5	18.9	56.0	46.0	19.5	27.1	VB
11	16.06200	23.8	18.6	11.0	34.8	29.6	60.0	50.0	25.2	20.4	VB
12	16.08280	25.6	20.1	11.1	36.7	31.2	60.0	50.0	23.3	18.8	VA



5. Radiated Emission

5.1. Measurement Procedure

5.1.1. Test Receiver Condition

Below 1000 MHz:	Detector: Quasi-peak Bandwidth: 120 kHz
Above 1000 MHz:	Detector: Average, Peak Bandwidth: 1 MHz

5.1.2. Frequency Range

30 MHz – 2000 MHz

5.1.3. Measuring Distance

3 m

5.1.4. Turn Table

Rotated 0 to 360 degrees

5.1.5. Antenna Position

Antenna height:	1 m to 4 m
Polarization	Horizontal and Vertical

5.1.6. Reported Emissions

At least the 6 points corresponding to the highest disturbance are reported.

5.1.7. Test Configuration

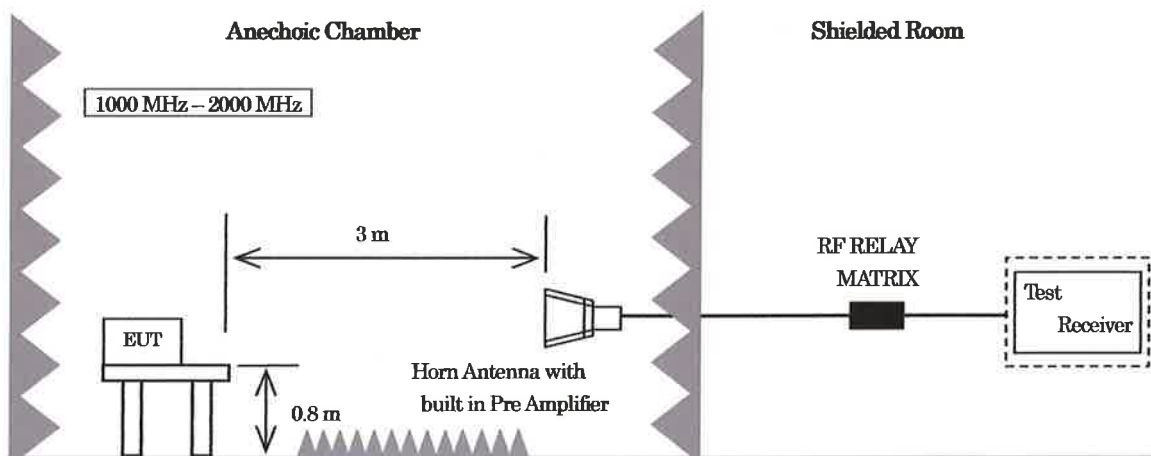
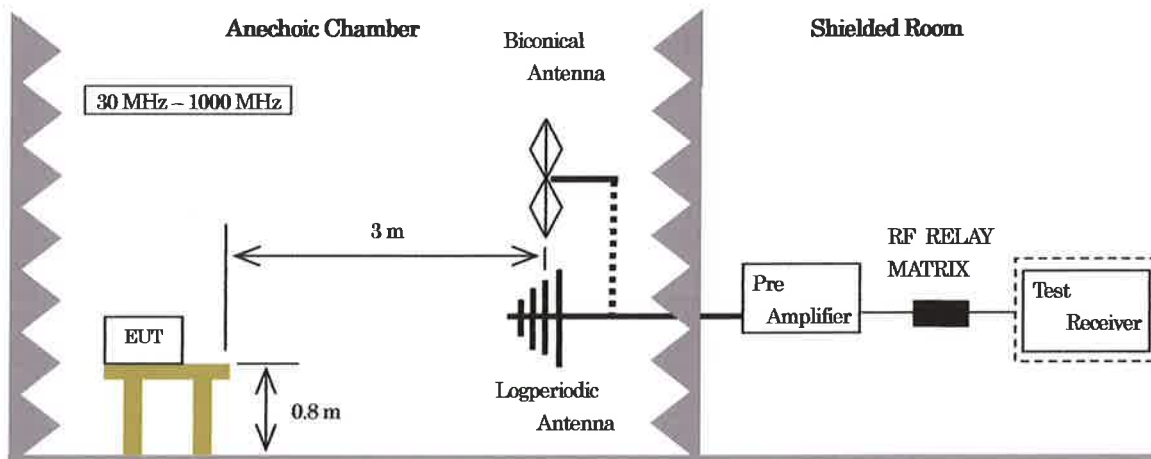

5.2. Test Equipment

Equipment	Manufacturer	Model No.	Serial or ID No.	Calibration Due
Test Receiver	Rohde & Schwarz	ESU26	100299	Apr-2017
Pre Amplifier	Sonoma	310N	243232	Aug-2017
RF RELAY MATRIX	tsj	RFMI2A2M	03153	Aug-2017
Biconical Antenna	Schwarzbeck	BBA9106(VHA9103)	91032277	Feb-2017
Logperiodic Antenna	Schwarzbeck	UHALP9108A	0720	Feb-2017
Horn Antenna	EMCO	3115	8912-3303	Dec-2016
Pre Amplifier for Horn Antenna	tsj	MLA-0108AD-39	005	Dec-2016
Attenuator	SUHNER	6803.17.A	003	Aug-2017
Attenuator	SUHNER	6803.17.A	004	Aug-2017
Coaxial Cable (1)	SUHNER	RG400	259	Aug-2017
Coaxial Cable (2)	SUHNER	RG400	260	Aug-2017
Coaxial Cable (3)	SUHNER	S04272B	612	Aug-2017
Coaxial Cable (4)	SUHNER	S04272B	376	Aug-2017
Coaxial Cable (5)	SUHNER	SF106	32550/6	Aug-2017
Coaxial Cable (6)	SUHNER	SF104EA	MY4490/4EA	Aug-2017
Software	tsj	TEPTO-DV/RE	v1.90.0098	N/A

Note 1: All testing equipment is calibrated with measuring equipment which are traceable to national or international standards.

Note 2: The pre-amplifier is connected to the horn antenna. (3115)

5.3. Sample Calculation

Radiated Emission Class B Limit*

Frequency Range (MHz)	Limit(dBuV/m)
	Quasi Peak
30 – 88	40.0
88 – 216	43.5
216 – 960	46.0
960 – 1000	54.0

*: The lower limits apply at the transition frequency.

Radiated Emission Class B Limit

Frequency range (MHz)	Limit(dBuV/m)	
	Average	Peak
Above 1000	54.0	74.0

• Example @ 519.744 MHz for Continuous Mode

$$\begin{array}{rcl}
 \text{Disturbance Level} & = & \text{Reading} & 38.2 \text{ dBuV} \\
 & + & \text{Correction Factor*} & -2.5 \text{ dB/m} \\
 & & & \hline
 & & = & 35.7 \text{ dBuV/m}
 \end{array}$$

$$\begin{array}{rcl}
 \text{Margin} & = & \text{Limit} & 46.0 \text{ dBuV/m} \\
 & - & \text{Disturbance Level} & 35.7 \text{ dBuV/m} \\
 & & & \hline
 & & = & 10.3 \text{ dB}
 \end{array}$$

*: Correction Factor = Antenna Factor (dB/m) + Cable Loss (dB) [include 3dB attenuator×2] – Pre Amplifier Gain (dB)

Note: The sample calculation above is the minimum margin at the measuring frequency.

5.4. Uncertainty

Expanded uncertainties were calculated with a coverage factor k = 2 for Radiated Emission.

• 30 MHz – 1000 MHz

+3.82 dB / -3.91 dB

• 1 GHz – 8 GHz

+3.83 dB / -3.85 dB

ISHIKAWA Co., Ltd. EMC Laboratory
2-3-18, Namamugi, Tsurumi-ku, Yokohama, Kanagawa 230-0052 Japan
TEL: +81 45-500-2255 FAX: +81 45-500-2256

5.5. Test Data

Radiated Emission

10m A/C
Date : 2016/09/13 13:33

Model Name : CMOS Area Scan Camera
Model No. : GO-5101C-PMCL
Serial No. : α0003
Test Condition : Continuous Mode
Data No. : IE1609-008A-03
Power Supply : DC 12V
Temp./Humi. : 23°C / 58%
Operator : A. Piroddi

Memo :

LIMIT : FCC Part15 SubpartB ClassB(3m)

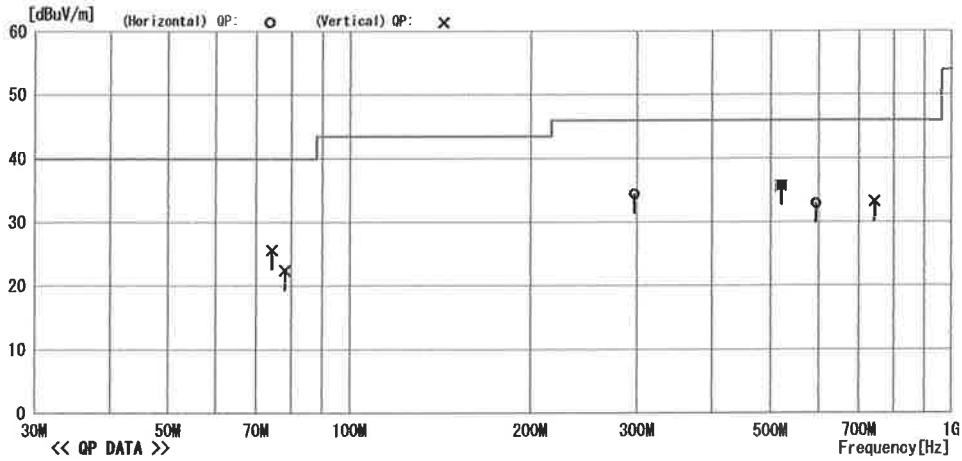

No	Freq.	Reading	Ant. Fac	Loss	Gain	Result	Limit	Margin	Pola.	Height	Angle	Ant
	[MHz]	[dBuV]	[dB/m]	[dB]	[dB]	[dBuV/m]	[dBuV/m]	[dB]	[H/V]	[cm]	[deg]	Type
1	74.249	42.6	6.6	8.0	31.6	25.6	40.0	14.4	Vert.	100	0	B1C
2	78.080	39.5	6.5	8.0	31.6	22.4	40.0	17.6	Vert.	100	186	B1C
3	296.996	36.9	19.3	9.9	31.7	34.4	46.0	11.6	Hori.	120	271	B1C
4	519.744	38.2	18.1	11.1	31.7	35.7	46.0	10.3	Hori.	100	271	LPD
5	519.744	38.2	18.1	11.1	31.7	35.7	46.0	10.3	Vert.	100	158	LPD
6	593.993	34.0	19.2	11.5	31.8	32.9	46.0	13.1	Hori.	100	323	LPD
7	742.491	32.2	20.7	12.1	31.8	33.2	46.0	12.8	Vert.	100	97	LPD



Radiated Emission

10m A/C
 Date : 2016/09/13 16:03

Model Name : CMOS Area Scan Camera	Data No. : IE1609-008A-11
Model No. : GO-5101C-PMCL	Power Supply : DC 12V
Serial No. : α 0003	Temp/Humi : 23°C / 58%
Test Condition : Continuous Mode	Operator : A. Pirroddi

Memo :

LIMIT : FCC Part15 SubpartB ClassB (3m) Peak

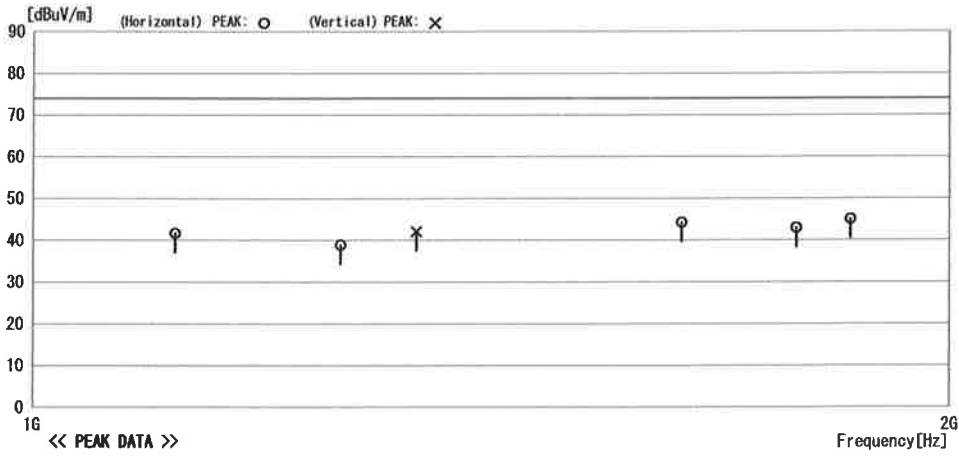

No	Freq.	Reading	Ant. Fac	Loss	Gain	Result	Limit	Margin	Pola.	Height	Angle	Ant
	[MHz]	[dBuV]	[dB/m]	[dB]	[dB]	[dBuV/m]	[dBuV/m]	[dB]	[H/V]	[cm]	[deg]	Type
1	1113.735	50.5	25.7	6.3	40.8	41.7	74.0	32.3	Hori.	160	86	HOR
2	1262.236	47.5	25.7	6.7	41.0	38.9	74.0	35.1	Hori.	125	99	HOR
3	1336.487	50.6	25.7	6.8	41.0	42.1	74.0	31.9	Vert.	110	59	HOR
4	1633.481	52.0	26.0	7.6	41.3	44.3	74.0	29.7	Hori.	100	292	HOR
5	1781.980	49.4	27.1	7.9	41.4	43.0	74.0	31.0	Hori.	216	309	HOR
6	1856.230	51.1	27.4	8.1	41.5	45.1	74.0	28.9	Hori.	100	222	HOR

Radiated Emission

10m A/C
 Date : 2016/09/13 16:03

Model Name : CMOS Area Scan Camera	Data No. : IE1609-008A-12
Model No. : GO-5101C-PMCL	Power Supply : DC 12V
Serial No. : α0003	Temp/Humi : 23°C / 58%
Test Condition : Continuous Mode	Operator : A. Piroddi

Memo :

LIMIT : FCC Part15 SubpartB ClassB (3m)

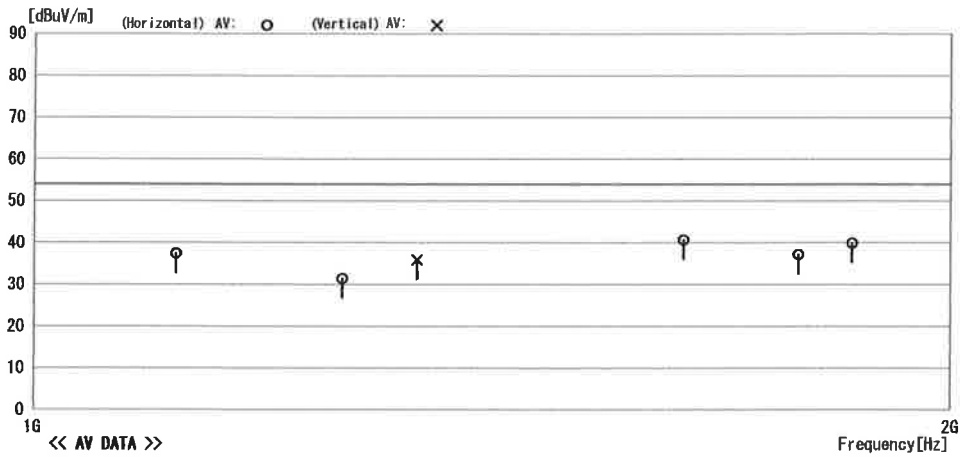

No	Freq. [MHz]	Reading [dBuV]	Ant. Fac [dB/m]	Loss [dB]	Gain [dB]	Result [dBuV/m]	Limit [dBuV/m]	Margin [dB]	Pola. [H/V]	Height [cm]	Angle [deg]	Ant Type
1	1113.735	46.2	25.7	6.3	40.8	37.4	54.0	16.6	Hori.	160	86	HOR
2	1262.236	40.0	25.7	6.7	41.0	31.4	54.0	22.6	Hori.	125	99	HOR
3	1336.487	44.4	25.7	6.8	41.0	35.9	54.0	18.1	Vert.	110	59	HOR
4	1833.481	48.4	26.0	7.6	41.3	40.7	54.0	13.3	Hori.	100	292	HOR
5	1781.980	43.6	27.1	7.9	41.4	37.2	54.0	16.8	Hori.	216	309	HOR
6	1858.230	45.9	27.4	8.1	41.5	39.9	54.0	14.1	Hori.	100	222	HOR

6. Photographs

6.1. Conducted Emission at Mains Port



6.2. Radiated Emission

• 30 MHz – 1000 MHz





• 1000 MHz – 2000 MHz



ISHIKAWA Co., Ltd. EMC Laboratory
2-3-18, Namamugi, Tsurumi-ku, Yokohama, Kanagawa 230-0052 Japan
TEL: +81 45-500-2255 FAX: +81 45-500-2256

7. Laboratory Description

7.1. Location

ISHIKAWA Co., Ltd. EMC Laboratory
2-3-18, Namamugi, Tsurumi-ku, Yokohama, Kanagawa 230-0052 Japan
TEL: +81 45-500-2255 FAX: +81 45-500-2256

7.2. Laboratory Equipment

Site Name	Shielded room Volume	Turn table	Weight-proof
Shielded room No. 1	4.9m×2.9m×2.8m	-----	-----
Shielded room No. 2	8m×5m×2.8m	-----	-----
10m Anechoic chamber	21.5m×13.5m×8.9m	4m diameter	3,000 kg
3m Anechoic chamber	9m×6m×5.7m	2m diameter	500 kg

7.3. Laboratory Filing or Certificate Information

7.3.1. VCCI Site Registration pursuant to V-5

Site Name	Registration No.	Expiry Date
ISHIKAWA Co., Ltd.	A-0105	July 14, 2017

7.3.2. FCC Site Filing pursuant to CFR 47 § 2.948

Site Name	Test Firm Registration No.	Expiry Date
ISHIKAWA Co., Ltd.	743690	July 5, 2017

7.3.3. VLAC Accreditation

Site Name	Accreditation No.	Expiry Date
ISHIKAWA Co., Ltd. EMC Laboratory	VLAC-025	July 14, 2017

7.3.4. TÜV Rheinland Certificate of Appointment Laboratory

Site Name	Registration No.	Expiry Date
ISHIKAWA Co., Ltd. EMC Laboratory	UA50060145-0012	June 1, 2017

7.3.5. Industry Canada site filing pursuant to RSS-Gen

Site Name	File No.	Expiry Date
10m Anechoic chamber	5804A-1	August 19, 2018
3m Anechoic chamber	5804A-2	August 19, 2018