

PULNiX

TM-1400

General Description

The TM-1400 is a miniature, high-resolution (1.4 megapixels) monochrome progressive scan CCD camera. The imager resolution is 1392 x 1040 pixels and the frame rate is 15 and 30 frames per second. The interline transfer CCD permits full vertical and horizontal resolution of high-speed shuttered images. The electronic shutter has speeds up to 1/16,000 sec. and can be reset asynchronously by external pulse control.

The TM-1400 has a patent-pending, PULNiX exclusive, built-in dual look-up table (LUT). This full dynamic range control function can be set at externally selectable knee slopes to optimize the CCD's full dynamic range in the normal output signal range. It also provides fast 10-bit to 8-bit pre-processing for effective image feature enhancement. The camera has both analog and digital (RS-644) output for interfacing with frame grabbers.

All camera-control functions are externally controlled via a user-friendly RS-232C graphical interface provided by PULNiX.

Applications for the TM-1400 include machine vision, medical imaging, intelligent transportation systems, high-definition graphics, gauging, character recognition, documents archiving, and surveillance.

Asynchronous Reset

The TM-1400's asynchronous reset is flexible and accepts external horizontal drive (HD) for phase locking. When the VINIT pulse is applied, it resets the camera's scanning and purging of the CCD. There are two modes to control the asynchronous reset and shutter speed:

1 External VINIT with pulse width. The duration between pulse edges controls the shutter speed externally.

2 Internal shutter speed control. The speed control varies from 1/125 to 1/16,000 sec. The video signal and FDV starts with internal V reset timing related to shutter speed.

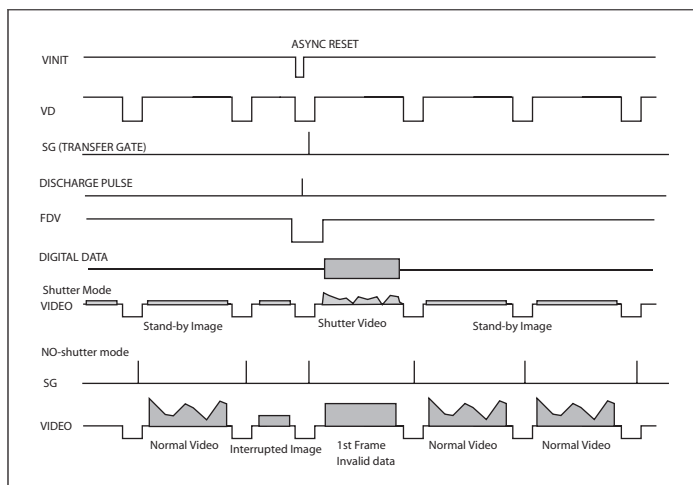

Product Summary

- High-resolution 1/2" progressive scan 1392(H) x 1040(V) interline transfer CCD imager
- Miniature 44x44x64 mm housing with high-rel connector
- Digital RS-644 (LVDS) output and analog output
- 15 frames and 30 frames per second selectable
- Maximum dynamic range control with PULNiX-exclusive, patent-pending built-in look-up table (Gamma, knee, user parameters)
- Full frame integration
- Image center partial scan (500, 250 lines)
- Full-frame shutter to 1/16,000 sec.
- Asynchronous reset, no-delay shutter and read-out-inhibit control for multiple-camera applications
- RS-232 external control
- Near IR sensitivity and high gain CCD output
- Color version (RGB Bayer CFA) is available (TMC-1400)

Electronic Shutter

The TM-1400 has a substrate drain-type shutter mechanism which provides a superb picture at various speeds without smearing. A built-in manual shutter speed control selects the electronic shutter rate of 1/60 (non-async mode only), 1/125, 1/250, 1/500, 1/1,000, 1/2,000, 1/4,000, 1/8,000, or 1/16,000 second (double the speed at 30 fps mode).

The CCD discharges when discharge pulse is applied via internal shutter control. With a negative pulse to VINIT, the camera resets and purges the CCD charge momentarily. Then it starts integrating for the period of preset shutter control time by either an external pulse width or internal shutter control.

Progressive scanning permits a full 1040 lines of vertical resolution, as compared to a conventional CCD camera which captures only half the vertical lines per shutter.

Integration

The CCD imager of the TM-1400 can be exposed for longer than the normal scan timing of 1/15 sec. This integration feature provides extra sensitivity for dark-environment applications. The progressive-scan imager permits a full frame of resolution in non-interlace format. Integration is achieved by applying INTEG signal to pin #11 of the 12-pin connector or pin #6 of the 31-pin connector, or by feeding VINIT pulse width control up to 1 sec of the pulse width.

Dynamic Range Control

Typical interline transfer CCDs have fixed noise levels based on dark current (thermal or KT noise), pattern noise, and operating clock speed. Typically for a 1k x 1k CCD operating at 25.0MHz pixel clock, the noise level is around 30 electrons. The maximum capacity of the CCD charges is limited by the well capacity at saturation. The range is limited by the structure and the pixel size.

The TM-1400 uses a 1/2" CCD with 4.65 μm x 4.65 μm pixel and three-phase vertical shift register structure. The well capacity is 8,000 electrons. The theoretical dynamic range is 8,000:30 = 267:1 (48 dB).

A typical CCD camera does not use the full dynamic range due to the nominal gain and the output specification such as RS-170. The typical CCD camera has its gain set at 16 to 22 dB and the RS-170 video level is 714 mV. Using 20 dB gain for the calculation, CCD output is limited to 714/10 = 71.4 mV. Since the CCD's saturation voltage is 400 mV to 500 mV, it uses less than 1/5 of the full dynamic range.

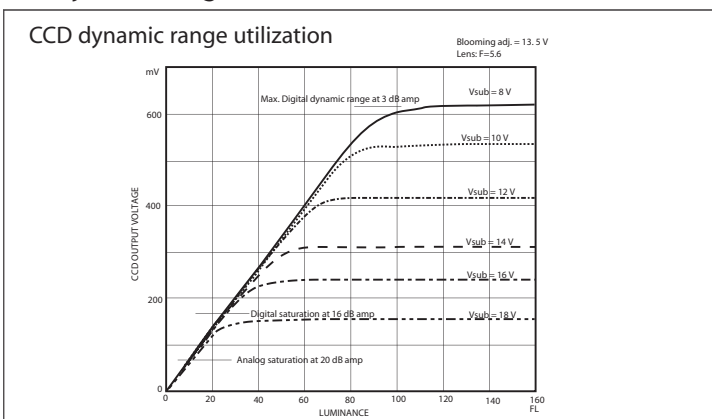

Machine vision and outdoor applications cannot afford to miss image information behind the saturation, which is why the dynamic range adaptation is critical.

Programmable LUT and Knee Control

(patent pending)

The TM-1400 has a built-in LUT (look-up table) for dynamic range control.

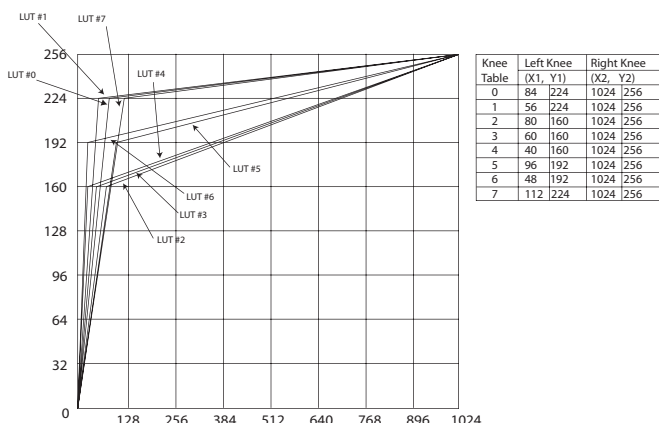

Note: The second knee point on the built-in LUT defaults to position (1024, 256). To reposition this point, click on it and drag it to a new location.

At a specific gain setting, the offset (minimum level... dark point) and A/D reference top voltage (maximum level... saturation point) are set to 10-bit A/D input so that the full dynamic range of the CCD is utilized at 10-bit references as the input and the LUT output is converted into 8-bit to adjust the gamma correction.

The look-up table has two knee points (variable gamma selection) that allow the 10 bits to be segmented into three regions. The look-up table selection can be made either by variable knee curve or by direct input of the knee coordinates.

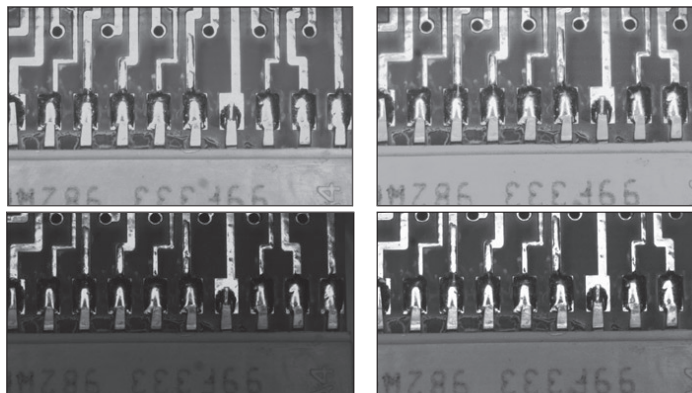

Linear image: When PCB surface is visible, metal trace is saturated. If the metal surface appears, then the plastic surface is too dark.

Knee-controlled image: The upper is LUT#6, the lower is #7. Both show the full dynamic range with different effects.

Scan Mode

Full Progressive Scan

Normal scanning mode for the TM-1400 is 1392 x 1040 pixels. The standard speed with single-channel output is 30 frames/sec. at the pixel clock of 50.0 MHz. (It can also be set to run 15 frames per second at 25.0 MHz.) Unlike an interlace scan camera, the TM-1400 reads every line from top to bottom, resulting in all lines being obtained per captured image frame with electronic shutter.

Partial Scan

500 lines and 250 lines partial scan is selectable. It outputs image center of 500 lines and 250 lines. At 500 lines the frame rate is 56 frames/sec. At 250 lines, it is 99 frames. Standard partial scan control is only available in 30fps mode.

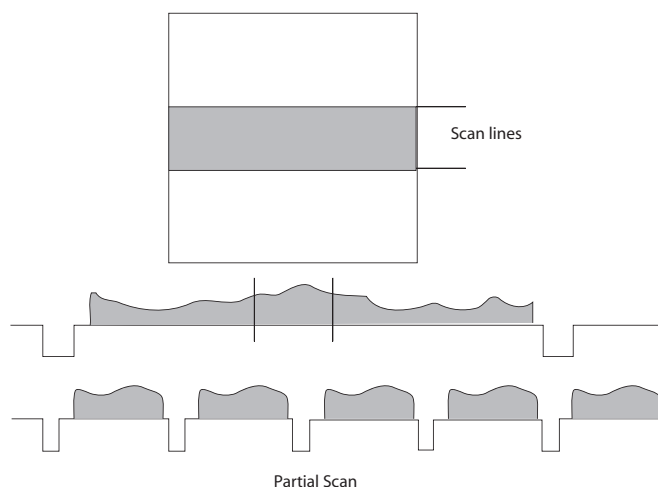

External Sync

The TM-1400 accepts an external sync. of standard HD and VD at TTL level for general locking to a system sync. and clock. External sync. is available for 30-frame mode only. The frequency requirement is as follows:

$$f_{HD} = 31.09 \text{ KHz} \pm 2\%$$

$$f_{VD} = 29.5 \text{ Hz} \pm 2\%$$

(Internal Master clock = 100.0 MHz,

Pixel clock = 25.0 or 50.0 MHz)

Please contact PULNiX for TM-1400 timing charts.

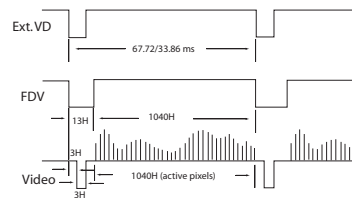
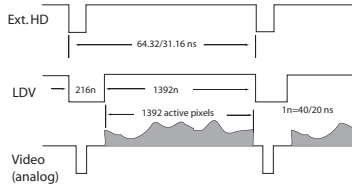

No-delay Shutter and Read-out-inhibit

For multiple-camera applications such as 2D or 3D measurement and multi-angle inspection, simultaneous image capturing at an exact shutter timing for all cameras is a critical requirement. The TM-1400's **async pulse width control mode** provides no-delay shutter as standard. Regardless of internal pulse timing, it discharges at VINIT's leading edge and transfers charges at the trailing edge of the pulse. Even though each camera runs with slightly different H and data clock timing, image capturing is exactly simultaneous.

The TM-1400 also has read-out-inhibit control (ROI) to control the vertical clock start (**Async Shutter #9**). When ROI is low, V-clock is stopped and the transferred charges remain in the vertical shift registers, which works like CCD memory. When ROI is high, it clocks out the CCD data. This helps a single frame grabber process multiple images in pipeline processing (sequential process).

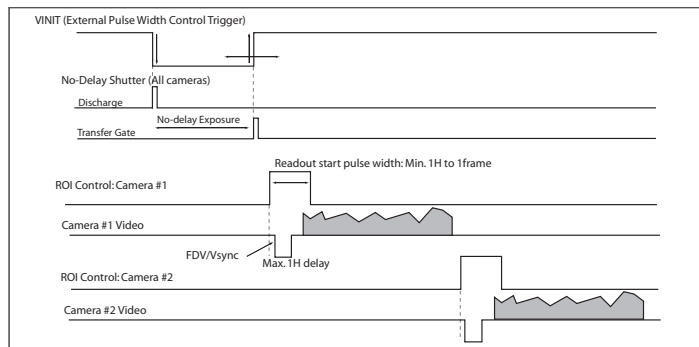

Mode Switches

Various modes can be implemented with the rear panel-mode selection switch and Up/Down switch as well as RS-232 external control. When RS-232 is connected, the command overwrites the rear panel switch settings.

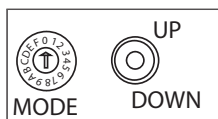

Connector and Pin Configurations

Mode Switch	Up/Down Switch	Functions
0 Switch Disabled	Switch Disabled	None
1 Set Gain	Up / Down	Change gain
2 Set Vtop (A/D)	Up / Down	Change A/D ref. top
3 Set Vbottom (A/D)	Up / Down	Change A/D ref bottom
4 Gain Selection #1	Up: 9dB, Down: 12dB	Lower gain selection
5 Gain Selection #2	Up: 18dB, Down: 22dB	Higher gain selection
6 Linear LUT	Up	Back to linear table
7 Knee Selection	Up / Down (Scroll)	Scroll 8 different LUTs
8 Async Reset Mode	Up: Normal, Dwn: Async	Async and normal shutter
9 Factory Default Recall	Up / Down: Recall	Factory setting
A Power up Setting	Up: Recall, Dwn: Save	Power up page setting
B User Page Storage#1	Up: Recall, Dwn: Save	User page storage setting
C User Page Storage#2	Up: Recall, Dwn: Save	User page storage setting
D Direct Shutter Control	Up / Down	Shutter speed increment by 1H
E Scan Format2	Up: 500, Dwn: 250	Partial selection
F Scan Format1	Up: 30 fps, Dwn: 15 fps	Custom option scanning

Digital Output Connector

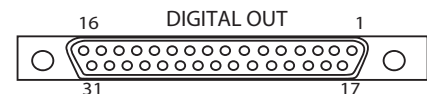

31-Pin Connector (MQ21-031-113-4300)

Pin#	Description	I/O	Pin#	Description	I/O
1	CLK+	Out	17	CLK-	Out
2	LDV+	Out	18	LDV-	Out
3	FDV+	Out	19	FDV-	Out
4	GND		20	VINIT (TTL)	In
5	EXT HD (TTL)	In	21	EXT VD (TTL)	In
6	INTEG/ROI (TTL)	In	22	N/C	
7	N/C		23	GND	
8	D0+	Out	24	D0-	Out
9	D1+	Out	25	D1-	Out
10	D2+	Out	26	D2-	Out
11	D3+	Out	27	D3-	Out
12	D4+	Out	28	D4-	Out
13	D5+	Out	29	D5-	Out
14	D6+	Out	30	D6-	Out
15	D7+	Out	31	D7-	Out
16	GND				

Note: CLK: data clock, LDV: Line data valid, FDV: Frame data valid, INTEG: Integration control, EXT CLK: external pixel clock, []: Differential input option

12-Pin Connector

1 GND (power)	7 VD in
2 +12V	8 GND
3 GND (analog)	9 HD in
4 Video out	10 RXD(RS232)
5 GND (digital)	11 INTEG/ROI
6 VINIT in	12 TXD(RS232)

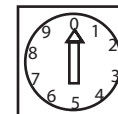
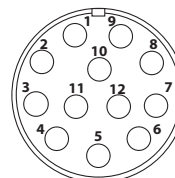

Shutter Control Switch

	Manual	Async
0	no shutter	no shutter
1	1/15	1/15
2	1/60	1/16,000
3	1/125	1/8,000
4	1/250	1/4,000
5	1/500	1/2,000
6	1/1,000	1/1,000
7	1/2,000	1/500
8	1/4,000	1/250
9	1/8,000	1/125
9	1/16,000	Ext. pulse width control

(For 30 fps mode, the shutter speed doubles)

SPECIFICATIONS

Imager	1/2" progressive scan interline transfer CCD
Active Area	6.47mm x 4.84mm
Active Pixels	1392 (H) x 1040 (V)
Cell size	4.65µm x 4.65µm
Display Mode (Active Pixels)	1392 (H) x 1040 (V) @ 15/30 Hz 1392 (H) x 500, 250 (V) @ partial scan
Sync*	Internal/external auto switch HD/VD, 4.0 Vp-p impedance 4.7K Ω VD=15 / 30 Hz ± 2%, non-interlace HD=15.55 / 31.09 kHz ± 2%
Data clock output	50.00 / 25.00 MHz
Resolution	Digital: 1392 (H) x 1040 (V), Analog: over 900 TV lines (H) x 800 TV lines (V)
S/N ratio	48 dB min (AGC off)
Min. illumination	1.0 lux, f=1.4 (no shutter) @ 30 fps Sensitivity: 50µ V/e-
Video output	Analog: 714 mV, 75 Ω (900 mV white clip) Digital output: 8-bit RS-644

AGC	OFF
Gamma	Programmable LUT (1.0 std)
Lens mount	C-mount (use > 2/3" format lenses)
Power req	12V DC ± 10%, 380 – 520 mA (current measured at 25°)
Operating temp†	-10°C to 50°C
Vibration	7Grms (10 Hz to 2000 Hz) Random
Shock	70G
Size (W x H x L)	44mm x 44mm x 64mm (1.73" x 1.73" x 2.51")
Weight	133 grams, 4.7 oz (without tripod)

MUST BE ORDERED SEPARATELY	
Opt. Functions	Adjustable back-focus front end, 12 fps, 24 fps
Opt. Accessories I/O	30DG-02 digital output cable CS-232E serial communication kit
Power cable	12P-02S power cable with open leads
Power supply	PD-12UUP series (includes power connector)

* External sync only at 30 fps.

† Image quality will degrade with increasing temperature.

Graphical User Interface

A user-friendly graphical user interface (GUI) is provided in the CS-232E kit. This interface allows users to control the following functions of the TM-1400 camera:

- Shutter control for manual async. and pulse width control
- Gain control
- A/D reference voltages control for Vtop and Vbottom
- Save settings
- Load settings
- Report settings
- LUT setting and graphic display
- Scanning mode selection and Option selections

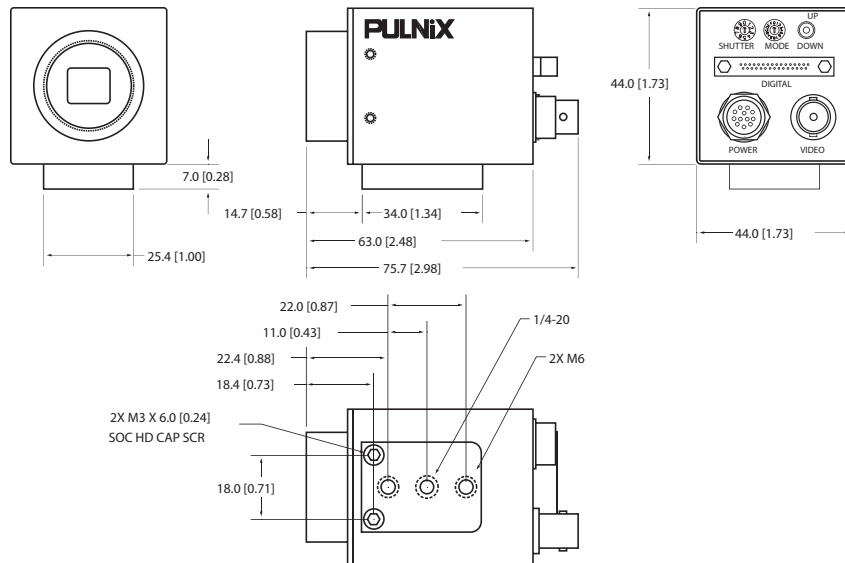
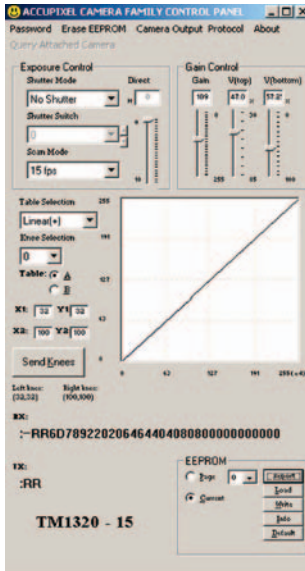

Camera parameters can be uploaded from the PC to the camera. Once these parameters are stored in EEPROMs, an instantaneous change from one setting to another can be done with a delay of few frames in between.

Serial Communication Kit

The serial communication kit CS-232E consists of serial cable RS-232B-12, a software disk, and a quick-start guide. The RS-232B-12 cable has a 12-pin connector on the camera end, and a 9-pin D-sub connector (RS-232) and a 12-pin connector (power and sync signals) on the other end.

JAI A-S, Denmark
Phone +45 4457 8888
www.jai.com

JAI UK Ltd., England
Phone: +44 189 582 1481
www.jai.com

JAI Corporation, Japan
Phone: +81 045 440 0154
www.jai-corp.co.jp

JAI PULNiX, Germany
Phone +49-(0) 60 55-93 79-10
www.jaipulnix.com

JAI PULNiX Inc., USA
1330 Orleans Drive
Sunnyvale
CA 94089
USA

Phone +1 408-747-0300
(toll-free) 1 800 445 5444
Fax +1 408 747 0660
www.jaipulnix.com

jai
PULNiX
www.jaipulnix.com

PULNiX Camera Link™ Cameras

Camera Link is a new digital transmission method, designed by vision product manufacturers specifically for the machine vision industry, in answer to customer requests. It is an easy way to connect digital cameras to frame grabbers.

Camera Link is a camera-to-frame grabber interface specification based on an implementation of Channel Link™ technology. It includes hardware (cable connectors), & data transmission as well as camera control and asynchronous serial communications all on a single cable. Now, only two connections (power and Camera Link) are required to operate the camera.

The specification was developed through an initiative headed by PULNiX America, Inc. Camera Link defines a single connector for both the frame grabber and the camera. This insures that all products bearing the Camera Link logo are interchangeable with each other. The official Camera Link logo is shown to the right.

As a standard that has been defined by industry members, Camera Link provides the following benefits:

- **Real-time signaling:** Camera Link supports real-time signaling. Camera Link cameras accept signals including asynchronous reset (Vinit), HD, VD, and integration through the Camera Link cable, without latency (delay).
 - **High data rates:** A base configuration Camera Link interface can handle 1.2Gbps of data. The technology used in Camera Link has a maximum data rate of 3.5Gbps, insuring solutions for tomorrow's applications.
 - **Flexibility:** Camera Link is independent of imager resolution, video format, and frame rate. In contrast, some other digital transmission standards are set for specific pre-defined video formats.
 - **Platform independence:** Camera Link is a hardware specification designed by camera and frame grabber manufacturers specifically for the Machine Vision industry. The frame grabber software must be Windows™ 9X/2000 compatible, but is independent of support from third parties like Microsoft, Apple, or Intel.
- **Simple interface:** Only two connections are required to interface a camera and frame grabber: Power and Camera Link. Cameras and frame grabbers can be easily interchanged using the same cable.
 - **Standardized cable assembly:** Camera Link specifies a standard cable assembly. This eliminates the need for manufacturers to provide custom cables, and allows customers to take advantage of lower cable prices. In addition, the technology used in Camera Link reduces the number of wires required to transmit data, allowing for thinner cables, which are more robust and less prone to breakage. Various cable lengths are available up to 10m.
 - **Extensive application software support from frame grabber and vision software companies:** Machine vision applications require robust and field-proven software. Camera Link is a quick and simple way for users to standardize their systems for existing applications without having to verify new software.
 - **Long-term, stable supply:** Channel Link technology is committed to providing long-term support to the telecommunications industry. Unlike most consumer products, the basic architecture will remain stable for many years to come.



Camera Link™ is a registered copymark of the AIA



Channel Link™ is a registered trademark of National Semiconductor.

Windows 2000™ is a registered trademark of Microsoft Corporation.

Channel Link Technology

The heart of Camera Link is Channel Link, a data transmission method by National Semiconductor. Channel Link is made up of a receiver chip and a transmitter chip. This chipset is used to transmit digital data. This technology offers many advantages to machine-vision applications over the previous method, namely, RS-644 (LVDS format of RS-422).

LVDS (Low Voltage Differential Signaling) has become the most common means to transmit digital data in recent years. This method, however, has several major drawbacks. LVDS requires a pair of wires for transmission of each data bit, creating bulky cables prone to breakage if stressed. Also, the maximum data transmission rate of LVDS is 400 Mbps, fast enough for today's applications, but limiting for tomorrow's requirements. Channel Link takes LVDS to the next level.

Channel Link uses LVDS standards to transmit data. Far fewer wires, however, are needed to transmit the data. A Channel Link transmitter will convert 28 bits of data into a format that can be transmitted over 4 parallel lines. A transmit clock over a fifth line finishes the requirements for Channel Link transmission. The diagram to the right shows how just five pairs of wire are able to transmit data that would require 56 wires using standard LVDS methods.

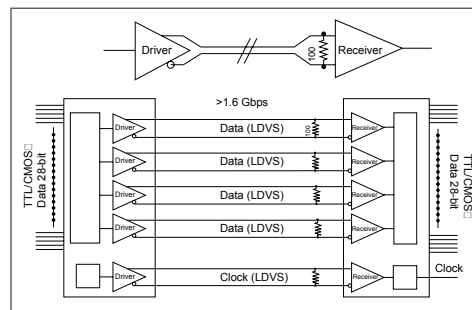

Camera Link Connector and Cable Configurations

A single Camera Link connection provides the following information on an MDR connector with 26 pins.

Image data and timing	4 pairs
	1 pair transmission clock
Serial communication	1 pair transmit
	1 pair receive
Camera Control	4 signal pairs

This configuration will transfer up to 28 bits of data. For applications that require more bandwidth, additional Camera Link connections can be used.

There are 3 configurations - base, medium and full. Please visit the PULNiX web site for detailed specifications of Camera Link.

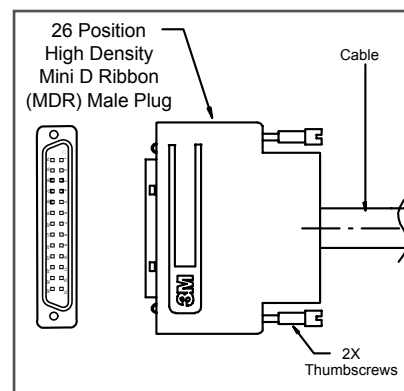

Camera Link Cable

Note: The MDR-26 cable assembly is manufactured by 3M Corporation.

Camera Link Cable Ordering Information

Camera Link cables are available from multiple vendors.

JAI PULNiX P/N	3M	Intercon I	Length
Molded Cables			
	14T26-SZLB-100-0LC	CLCP-1.0-p	
26CL-02-26	14T26-SZLB-200-0LC	CLCP-2.0-p	
	14T26-SZLB-300-0LC	CLCP-3.0-p	
	14T26-SZLB-500-0LC	CLCP-5.0-p	
	14T26-SZLB-700-0LC	CLCP-7.0-p	
	14T26-SZLB-A00-0LC	CLCP-10-p	
	14T26-SZLB-450-0LC	CLCP-4.5-p	
Shell Kit Cables			
	14B26-SZLB-100-0LC	CLCPH-1.0-p	
	14B26-SZLB-200-0LC	CLCPH-2.0-p	
	14B26-SZLB-300-0LC	CLCPH-3.0-p	
	14B26-SZLB-450-0LC	CLCPH-4.5-p	
	14B26-SZLB-500-0LC	CLCPH-5.0-p	
	14B26-SZLB-700-0LC	CLCPH-7.0-p	
	14B26-SZLB-A00-0LC	CLCPH-10-p	

Connector and Pin Configurations

Camera Link Connector (MDR 26-pin connector)

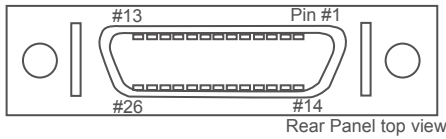

Rear Panel

TMC-6700CL/TMC-1000CL

AccuPiXEL™ Series

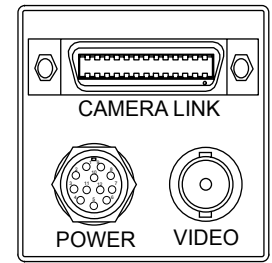
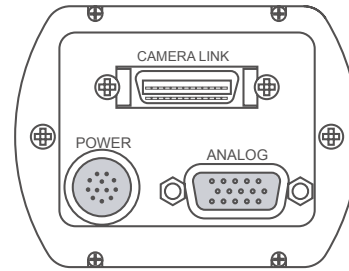

MDR 26-pin Connector 10226-6212VC

Pin#	Description	I/O
1	GND (shield)	
2	X0- (CH0-)	Out
3	X1- (CH1-)	Out
4	X2- (CH2-)	Out
5	Xclk- (CLK-)	Out
6	X3- (CH3-)	Out
7	SerTC+ (Rx+)	In
8	SerTFG- (Tx-)	Out
9	CC1- (Vinit/VD-)	In
10	CC2+ (Integ/ROI+)	In
11	CC3- (HD-)	In*
12	CC4+ (RCLK+)	In**
13	GND	
14	GND (shield)	
15	X0+ (CH0+)	Out
16	X1+ (CH1+)	Out
17	X2+ (CH2+)	Out
18	Xclk+ (CLK+)	Out
19	X3+ (CH3+)	Out
20	SerTC- (Rx-)	In (LVDS or RS-232)
21	SerTFG+ (Tx+)	Out
22	CC1+ (Vinit/VD+)	In
23	CC2- (Integ/ROI-)	In
24	CC3+ (HD+)	In*
25	CC4- (RCLK-)	In**
26	Inner shield	

The 26-pin Connector Pin Assignment (Camera Side)

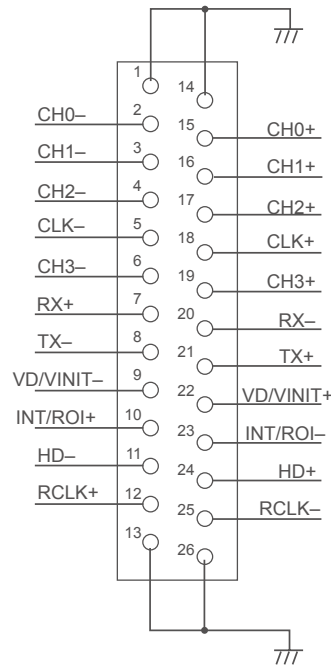

Node description:

CH0: Data B0, A5, A4, A3, A2, A1, A0

CH1: Data C1, C0, B5, B4, B3, B2, B1

CH2: Data DVAL, FVAL, LVAL, C5, C4, C3, C2

CH3: Data SPARE, C7, C6, B7, B6, A7, A6

CLK: Data clock

RX, TX: Serial communication, RX = Ser to Cam □

□ TX = Ser to FG

VD/VINIT: Ext. VD in or VINIT (Triger) in

INT/ROI: Integration control in or □

□ Read-Out-Inhibit in

HD: External HD in

RCLK: External read clock in

* HD, VD for external sync input. (Please contact PULNiX for Ext. HD input)

** RCLK is reserved for read clock input.

Camera Link Signal Assignment to Channel Link Chip (RGB 8-bit x 3)

Tx IN0	Data R0 (LSB)	Tx IN8	G1	Tx IN16	B6	Tx IN24	LDV
Tx IN1	Data R1	Tx IN9	G2	Tx IN17	B7	Tx IN25	FDV
Tx IN2	Data R2	Tx IN10	G6	Tx IN18	B1	Tx IN26	LPULSE
Tx IN3	Data R3	Tx IN11	G7	Tx IN19	B2	Tx IN27	R6
Tx IN4	Data R4	Tx IN12	G3	Tx IN20	B3	Tx CLK	Data clock
Tx IN5	Data R7 (MSB)	Tx IN13	G4	Tx IN21	B4		
Tx IN6	Data R5	Tx IN14	G5	Tx IN22	B5		
Tx IN7	Data G0	Tx IN15	B0	Tx IN23	(YCC CLK)		

Note1: CLK: data clock, LDV: Line data valid, FDV: Frame data valid, INTEG: Integration control, VINIT: Async Trigger Input, ROI: Read-out-inhibit.

Note2: Data R0-7 is defined as A0-7, Data G0-7 is defined as B0-7. Data B0-7 is defined as C0-7. For 8-bit B/W, only A0-7 is used. For 8-bit x 2 A0-7 and B0-7 are used.

Note3: Camera control via 12-pin connector (RS-232) is available as an option.

Camera Link Camera Models



Camera models B/W Cameras	CCD (In)	Resolution	Frame rate (frame/sec.)	Data Clock (MHz)	Data	Analog video	Size (HxWxL mm)
TM-6760CL	1/2	648 x 484	60/30	25.49/12.75	Ch-A 8-bit	BNC: VGA video	44 x 44 x 64
TM-6710CL	1/2	648 x 484	120/60	25.49/12.75	Ch-A & B 8-bit x 2	BNC: 120 fps @ 50MHz	39 x 46 x 140
TM-1400CL	1/2	1392 x 1040	20	33.3	Ch-A 8-bit	BNC: progressive scan	44 x 44 x 64
TM-1320A-15CL	2/3	1300 x 1030	15	25.0	Ch-A 8-bit	BNC: progressive scan	44 x 44 x 64
TM-1320A-24CL	2/3	1300 x 1030	24	40.0	Ch-A 8-bit	BNC: progressive scan	44 x 44 x 64
TM-1325CL	2/3	1392 x 1040	15/30	33.3	Ch-A 8-bit	BNC: progressive scan	44 x 44 x 64
TM-1020-15CL	1	1008 x 1018	15	20.0	Ch-A 8-bit	BNC: progressive scan	44 x 44 x 64
TM-2016-8CL	1	1920 x 1080	8	20.0	Ch-A 8-bit	BNC: progressive scan	44 x 44 x 64
TM-2016-15CL	1	1920 x 1080	15	40.0	Ch-A 8-bit	BNC: progressive scan	44 x 44 x 64
TM-4000CL	1.2	2048 x 2048	15	40.0	8-bit x 2	BNC: progressive scan	51 x 51 x 82
Color Cameras							
TMC-6700CL	1/2	648 x 484	60	25.49	Ch-R,G,B 8-bit x 3	Dsub: RGB video VGA video	51 x 67 x 117
TMC-1000CL	1	1008 x 1018	15	20.0	Ch-R,G,B 8-bit x 3	Dsub: RGB video progressive scan	51 x 67 x 117
TMC-6760CL ^Δ	1/2	648 x 484	60	25.49/12.75	Ch-A 8-bit	BNC: VGA video	44 x 44 x 64
TMC-6710CL	1/2	648 x 484	120	25.49	Ch-A & B 8-bit x 2	BNC: 120 fps @ 50MHz VGA video	39 x 46 x 140
TMC-1400CL ^Δ	1/2	1392 x 1040	20	33.3	Ch-A 8-bit	BNC: progressive scan	44 x 44 x 64
TMC-1320A-15CL ^Δ	2/3	1300 x 1030	15	25.0	Ch-A 8-bit	BNC: progressive scan	44 x 44 x 64
TMC-1320A-24CL ^Δ	2/3	1300 x 1030	24	40.0	Ch-A 8-bit	BNC: progressive scan	44 x 44 x 64
TMC-1325CL	2/3	1392 x 1040	15/30	33.3	Ch-A 8-bit	BNC: progressive scan	44 x 44 x 64
TMC-1020-15CL ^Δ	1	1008 x 1018	15	20.0	Ch-A 8-bit	BNC: progressive scan	44 x 44 x 64
TMC-2016-8CL ^Δ	1	1920 x 1080	8	20.0	Ch-A 8-bit	BNC: progressive scan	44 x 44 x 64
TMC-4000CL ^Δ	1.2	2048 x 2048	15	40.0	Ch-A & B 8-bit x 2	BNC: progressive scan	51 x 51 x 82

^Δ AccuPIXEL color cameras require software interpolation.

Please contact PULNiX for availability. For detailed camera specifications, please refer to the standard camera data sheet for each model.

For product updates and data sheets, see our web site:

www.jaipulnix.com

JAI A-S, Denmark
Phone +45 4457 8888
www.jai.com

JAI UK Ltd., England
Phone: +44 189 582 1481
www.jai.com

JAI Corporation, Japan
Phone: +81 045 440 0150
www.jai-corp.co.jp

JAI PULNiX, Germany
Phone +49-(0) 60 55-93 79-0
www.jaipulnix.com

JAI PULNiX Inc., USA
1330 Orleans Drive
Sunnyvale
CA 94089
USA

Phone +1 408-747-0300
(toll-free) 1 800 445 5444
Fax +1 408 747 0660
www.jaipulnix.com

PULNiX
www.jaipulnix.com

Company and product names mentioned in this document are trademarks or registered trademarks of their respective owners. JAI A-S cannot be held responsible for any technical or typographical errors and reserves the right to make changes to products and documentation without prior notification.

71-0048 Rev B.10.21.2003

PULNiX Color AccuPiXEL®

Color AccuPiXEL Series Cameras

New Product Summary

- High-resolution, high-speed progressive scan interline transfer CCD imagers
- Digital Camera Link, RS-644 (LVDS) output and analog output
- Bayer color filter arrays
- Maximum dynamic range control with built-in look-up table (Gamma, knee, user parameters)
- Full-frame integration, partial scan, two-row binning
- Smaller, lightweight housing with High-rel connector
- Full-frame shutter to 1/16,000 sec.
- Asynchronous reset, no-delay shutter, read-out-inhibit control
- RS-232 or Camera Link external control
- Excellent color reproduction with various color interpolation software

General Description

The PULNiX AccuPiXEL series color cameras are high-resolution, high-speed progressive scan CCD cameras. The interline transfer, progressive scan CCD permits full vertical and horizontal resolution of images acquired at very high shutter speeds. The electronic shutter, which has speeds to 1/16,000 sec., can be reset asynchronously by external pulse control. Uniform square pixels provide superior image definition in any orientation. On-chip micro lenses mean increased sensitivity.

Color Filter Array

PULNiX AccuPiXEL cameras use Bayer CFA (color filter array) as their standard primary color filter. This filter provides the most popular color interpolation supported by numerous software suppliers.

The digital format, either Camera Link or RS-644, allows the camera to output accurate pixel data, including the color information. When the data is stored in the frame buffer of a frame grabber or computer, the color information is easily manipulated to restore the original color images. Because the color filter array contains only a single R, G or B color in each pixel, the restored image has to fill in colors in the missing pixel locations. The software uses neighboring pixel information to “guess” the missing colors to make smooth, clear images. This is called “Color Interpolation.” Today’s high-speed computers allow such color interpolation to be done almost in real time. Because these cameras do not contain internal color-processing circuitry, they are smaller and less expensive than full-function color cameras.



Actual image taken with the TMC-1320



Bayer Color Filter Array (CFA)

The Bayer CFA is an R,G, B primary color filter array. This is the most widely accepted CFA for the single-chip CCD progressive scan format. The array layout has a specific order of each color pixels. Since the human eye’s resolution and color recognition are highest at green, the CFA contains two greens per each red and blue.

It is critical for the frame grabber and color interpolation to know where the individual color pixels exist relative to sync (LDV and FDV) timing.

This requirement makes digital output the preferred choice, because the timing relationships are very accurate.

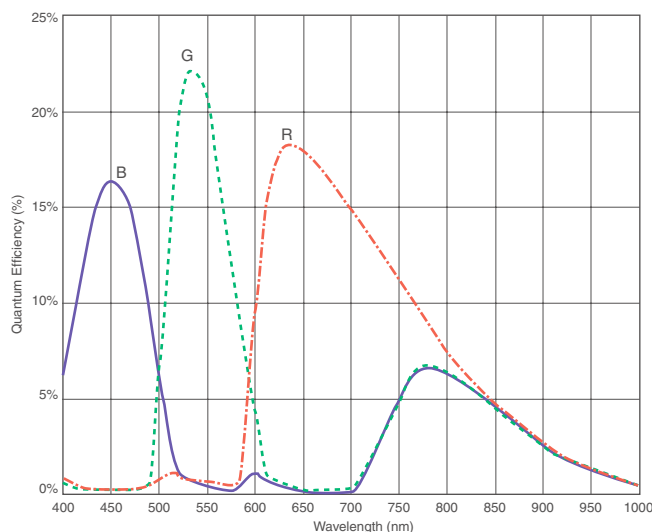

Starting pixel configuration

All manufacturers produce identical Bayer CFAs, but there are slight differences between the CCDs produced by different manufacturers. The first line is generally R and G, except for the Kodak CCD, which starts with G. The Sony CCD starts with R. The camera timing can be adjusted to start with either G or R by skipping the very first pixels at each lines. The majority of color interpolation software can select between a variety of pixel relations, such as R/G start or G/R start as well as G/B start and B/G start. Once the correct scanning is configured, the rest of the interpolation will be exactly the same.

Please contact PULNiX for further information regarding CCD manufacturers

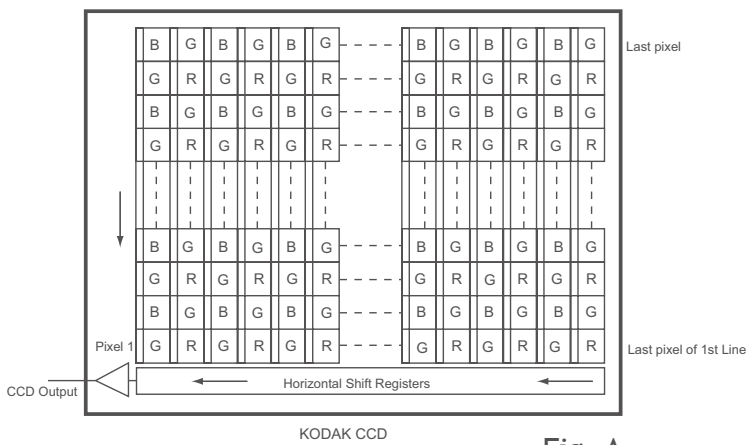

Fig. A

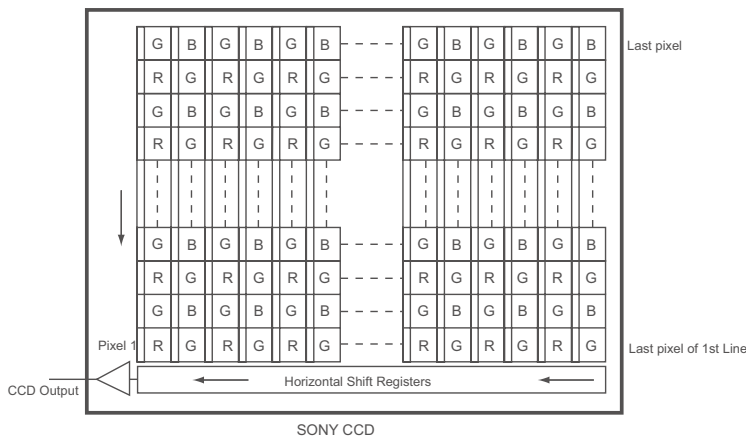

Fig. B

Sync and Data

The individual color data is exactly the same as the pixel data. This means that the timing relationships of the color cameras are also the same as of the B/W cameras.

For a detailed timing chart, please refer to each B/W camera's data sheet and manual.

If the frame grabber has a standard B/W configuration file, then AccuPiXEL color cameras can use that configuration file to operate. The configuration file may vary, depending on whether the output is standard (RS-644) or Camera Link. Please consult your frame grabber supplier or PULNiX for compatibility information.

The following diagram is an example of the TMC-1020-15 (same as TM-1020-15).

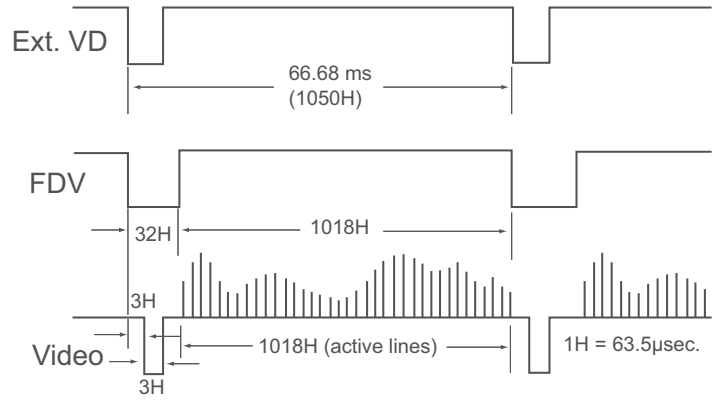
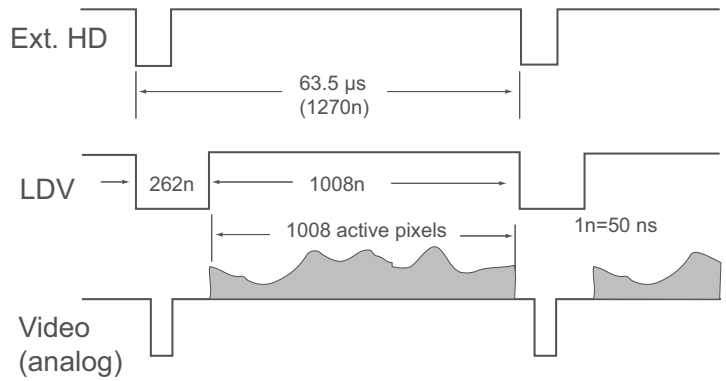

It is important to meet the exact starting pixel at LDV and the starting line of FDV. If the starting pixel or line is shifted due to the image capture configuration, then the interpolation software can be adjusted the starting point. In figure A, if the first pixel is shifted (missed), the color interpolation should start with R-G. If the first line is missed in A, the interpolation order will be B-G.

Camera functions

AccuPiXEL color cameras perform all functions the same way as B/W cameras. However, because of color characteristics, the following issues are different:

1. Two-row binning scan

When two rows are mixed in the CCD, the Bayer color is no longer valid. It provides color information but cannot be interpolated as a Bayer CFA.

2. LUT (Look-up Table)

LUT is a powerful tool to adjust the dynamic range as well as color dynamic range. Since human color perception is non-linear, LUT selection can help optimize color contrast by selecting the LUT value. Gamma 0.45 is logarithmic and it is closed to human perception.

When LUT is selected, black-level adjustment must be more accurate than for B/W cameras.

For a detailed timing chart, please refer to the standard AccuPiXEL camera data sheet, or contact PULNiX.

Basic Mode Selections (For Non-CL Versions)

	Mode Switch	Up/Down Switch	Function
0	Switch Disabled	Switch Disabled	None
1	Set Gain	Up / Down	Change gain
2	Set Vtop (A/D)	Up / Down	Change A/D ref. top
3	Set Vbottom (A/D)	Up / Down	Change A/D ref bottom
4	Gain Selection #1	Up: 9dB, Down: 12 dB	Lower gain selection
5	Gain Selection #2	Up: 18dB, Down: 22 dB	Higher gain selection
6	Linear LUT	Up	Back to linear table
7	Knee Selection	Up / Down (Scroll)	Scroll 10 different LUTs
8	Async Reset Mode	Up: Normal, Down: Async	Async and normal shutter
9	Factory Default Recall	Up / Down: Recall	Up / Down: Recall
A	Power Up Setting	Up: Recall, Dwn: Save	Power up page setting
B	User Page Storage #1	Up: Recall, Dwn: Save	User page storage setting
C	User Page Storage #2	Up: Recall, Dwn: Save	User page storage setting
D	Direct Shutter Control	Up / Down	Shutter speed increment by 1H
E	Scan Format2	Up: Optional Dwn: Binning	Two-row binning selection
F	Scan Format1	Up: Normal Dwn: Optional	Custom option scanning

**This mode description may change from camera model to camera model slightly. The same functions are controlled by RS-232 or Camera Link software.*

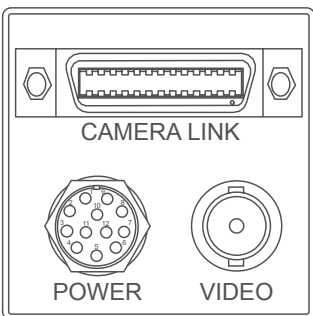

Camera Link model
rear panel

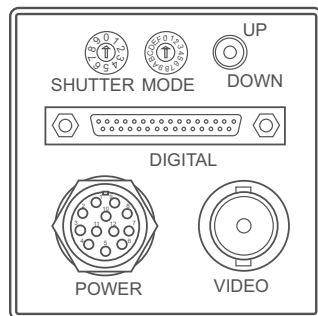

LVDS model real panel
Does not apply to TMC-4000

Interpolation software

Major frame grabber manufacturers with digital capability (Camera Link, RS-644) provide color interpolation software. Some independent image process software suppliers provide software as well.

The following table lists a few examples.

Manufacturer	Frame Grabber	Software
Matrox	Meteor II Digi, CL	MIL
Bitflow	Road Runner CL	Bay View
Coreco	T64	Application software
Data Cube	MaxRevolution	Visual Chip Studio
Epix	PIXCI	Application software
Euresys	GrabLink	Easygrab EasyColor
Matrix Vision	MV-Titan/CL	Impact
Silicon Software	microEnable III	microDisplay

Color Interpolation

The Bayer pattern color filter array (CFA) consists of R, G and B primary colors. Each pixel represents one of three colors. In order to display or print color images, the signal has to be converted to RGB output, which has three independent channels (outputs) and sync signals.

Color interpolation software or firmware performs the color preprocessing by filling the missing color pixels with neighboring pixels. It then separates the stream of data, (8-bit or 10-bit) into 3 (RGB) data (8-bit x 3) and adds the color matrix to adjust and balance each of the R,G, and B channels (White balance or color balance).

Green	Red	Green
Blue	Green	Blue
Green	Red	Green

The image quality depends on the camera's own pixel data (including pixel data independency from neighboring pixels, noise and color filter), and interpolation of the software algorithm such as 3 x 3 interpolation, 2 x 2 interpolation, color matrix, white balance capability, etc.

All AccuPiXEL color cameras are carefully designed for maximum color performance. PULNiX strongly suggests that you use digital output for the best performance.

Some software is used on board (FPGA or DSP) to perform the interpolation. Other software simply uses the host computer's memory and CPU. The process speed may vary depending on the architecture and speed of the computer.

Color AccuPiXEL Cameras

Camera models AccuPiXEL Color	CCD		Resolution	Frame Rate (frame/sec)	Data Clock (MHz)	Data	Analog video	Size (H x W x L in mm)
	Size	MFG						
TMC-6760	1/2"	Kodak	648 x 484	60/30	25.0/12.50	8-bit	BNC: VGA video	44 x 44 x 64
TMC-6760CL	1/2"	Kodak	648 x 484	60/30	25.0/12.50	CH-A 8-bit	BNC: VGA video	44 x 44 x 64
TMC-1400	1/2"	SONY	1392 x 1040	15/30	50/25	8-bit	BNC: progressive scan	44 x 44 x 64
TMC-1400CL	1/2"	SONY	1392 x 1040	15/30	50/25	CH-A 8-bit	BNC: progressive scan	44 x 44 x 64
TMC-1325	2/3"	SONY	1392 x 1040	15/30	55/27.5	8-bit	BNC: progressive scan	44 x 44 x 64
TMC-1325CL	2/3"	SONY	1392 x 1040	15/30	55/27.5	CH-A 8-bit	BNC: progressive scan	44 x 44 x 64
TMC-1020A-15	1"	Kodak	1008 x 1018	15	20.0	8-bit	BNC: progressive scan	44 x 44 x 64
TMC-1020A-15CL	1"	Kodak	1008 x 1018	15	20.0	CH-A 8-bit	BNC: progressive scan	44 x 44 x 64
TMC-2016-8	1"	Kodak	1920 x 1080	8	20.0	8-bit	BNC: progressive scan	44 x 44 x 64
TMC-2016-8CL	1"	Kodak	1920 x 1080	8	20.0	CH-A 8-bit	BNC: progressive scan	44 x 44 x 64
Dual-Tap AccuPiXEL Color	Size	CCD MFG	Resolution	Frame Rate (frame/sec)	Data Clock (MHz)	Data	Analog video	Size (H x W x L in mm)
TMC-4000CL	1.2"	Kodak	2048 x 2048	15	40.0	CH-A & B 8-bit x 2	BNC: progressive scan <i>CH-A only</i>	51 x 51 x 82

CL: Camera Link

Please contact JAI PULNiX for availability. For detailed camera specifications, please refer to the standard camera data sheet for each model.

For product updates and data sheets see our web site:

www.jaipulnix.com



Company and product names mentioned in this document are trademarks or registered trademarks of their respective owners. JAI A-S cannot be held responsible for any technical or typographical errors and reserves the right to make changes to products and documentation without prior notification.

71-0069 Rev. C.08.26.2004

JAI A-S, Denmark
Phone +45 4457 8888
www.jai.com

JAI UK Ltd., England
Phone: +44 189 582 1481
www.jai.com

JAI Corporation, Japan
Phone: +81 045 440 0154
www.jai-corp.co.jp

JAI PULNiX, Germany
Phone +49-(0) 60 55-93 79-10
www.jaipulnix.com

JAI PULNiX Inc., USA
1330 Orleans Drive
Sunnyvale
CA 94089
USA

Phone +1 408-747-0300
(toll-free) 1 800 445 5444
Fax +1 408 747 0660
www.jaipulnix.com



PULNiX
www.jaipulnix.com